

SHARP®

MODEL

AR-287

AR-337

AR-407

DIGITAL COPYING MACHINE

OPERATION MANUAL

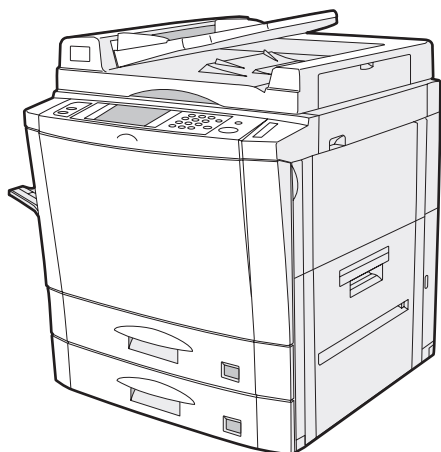

AR-287/AR-337

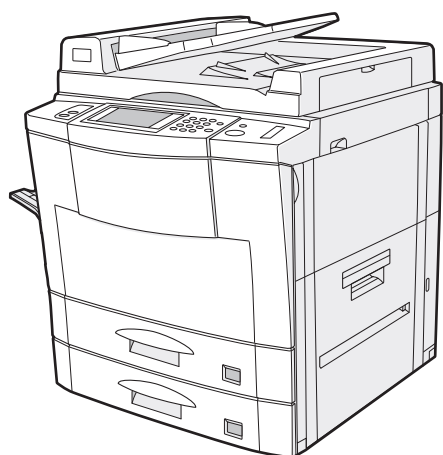

AR-407

	Page
• GETTING STARTED	1-1
• MAKING COPIES	2-1
• SPECIAL FUNCTIONS	3-1
• SUPPLIES	4-1
• COPIER TROUBLE?	5-1
• GENERAL INFORMATION	6-1
• OPTIONAL EQUIPMENT ...	7-1

The power switch positions are marked "I" to indicate power "ON" and "⏻" to indicate stand-by.

In the stand-by position, power is being supplied to a drying heater within the optical system of the copier.

Caution:

For complete electrical disconnection, pull out the main plug.

The socket-outlet shall be installed near the equipment and shall be easily accessible.

FOR YOUR RECORDS ...

To protect against loss or theft, record and retain for reference the copier's serial number located on the left hand side at the rear corner of the copier.

Model Number AR-287/AR-337/AR-407

Serial Number _____

Date of Purchase _____

Place of Purchase _____

Authorized Sharp Copier _____

Service Department Number _____

CONTENTS

	Page
● INTRODUCTION	2
● USING THIS MANUAL	2

CHAPTER 1 GETTING STARTED

● INSTALLATION REQUIREMENTS	1-2
● CAUTIONS	1-3
● POWER ON AND OFF	1-5
Power save modes	1-5
● INFORMATION FUNCTION	1-7
● USING THE TOUCH PANEL	1-8
How to use the touch panel	1-8
Selection of function	1-8
Function setting icons	1-9

CHAPTER 2 MAKING COPIES

● AUDITING ACCOUNTS	2-2
● USING THE RADF	2-3
● COPYING FROM THE DOCUMENT	
GLASS	2-8
● REDUCTION/ENLARGEMENT/ZOOM ..	2-11
● SPECIAL PAPERS (manual feed)	2-14
Two-sided copying with bypass tray	2-15
● EXPOSURE ADJUSTMENTS	2-16
● SORT/GROUP	2-17
● JOB MEMORY	2-18
● INTERRUPTING A COPY RUN	2-20

CHAPTER 3 SPECIAL FUNCTIONS

● XY ZOOM	3-2
● MARGIN SHIFT	3-4
● ERASE	3-6
● DUAL PAGE COPYING	3-8
● MULTI SHOT	3-10
● COVERS	3-13
● TRANSPARENCY FILM WITH	
INSERT SHEETS	3-15
● PAMPHLET COPY	3-17
● IMAGE EDITING FUNCTIONS	3-20
Job build	3-20
Centering	3-22
Repeat copy	3-24
B/W reverse	3-27
Binding change	3-29
● TEXT STAMP	3-32
Date	3-32
Select stamp	3-35
Watermark	3-38
Page number	3-41
● TANDEM COPY	3-44
● SETTING REVIEW	3-46

CHAPTER 4 SUPPLIES

● PAPER	4-2
Types and sizes of copy paper	4-2
Loading copy paper	4-2
● ADDING TONER	4-5
● USED TONER DISPOSAL	4-7
● STORAGE OF SUPPLIES	4-8

CHAPTER 5 COPIER TROUBLE?

● MISFEED REMOVAL	5-2
● MAINTENANCE REQUIRED	5-11
● TROUBLESHOOTING	5-12

CHAPTER 6 GENERAL INFORMATION

● PART NAMES AND FUNCTIONS	6-2
Exterior	6-2
Interior	6-3
Operation panel	6-4
Touch panel (Basic screen)	6-5
● USER MAINTENANCE	6-6
● TOUCH PANEL CONTRAST	
ADJUSTMENT	6-7
● SPECIFICATIONS	6-8

CHAPTER 7 OPTIONAL EQUIPMENT

● SYSTEM CONFIGURATION	7-2
● FINISHER (AR-FN1N)	7-3
● FINISHER (AR-FN2)	7-19
● LARGE CAPACITY TRAY (AR-LC1N) ...	7-30
● STAND/500-SHEET PAPER DRAWER	
(AR-DE1N)	7-34
● DUAL TRAY OUTPUT UNIT (AR-TR1) ..	7-37

INTRODUCTION

The AR-287, AR-337 and AR-407 copiers are digital image processing copiers which provide high productivity and convenient features including intelligent image-editing functions.

Amongst their many useful features and functions are the document feeder, various special functions such as dual page copying, margin shift, erase, XY zoom, and black and white reverse functions, photo copying, and an internal auditor. If this copier is connected with another copier of the same model equipped with the same options through the tandem-connection cable (AR-CA1), copying can be performed using the two copiers allowing copying to be twice as fast as copying on one copier when making multiple copies (tandem copying). Also, the JOB BUILD mode allows copies to be made of multipage documents of up to 120 pages (the limit, however, might be up to 60 pages of 8-1/2" x 14" or 11" x 17" paper size when the copier is equipped with some option) by dividing the document into sections small enough (50 pages or less) and sequentially feeding through the document feeder. The digital processing system of the copiers allows multiple sets of copies to be sorted without the aid of a sorter. These copiers can be equipped with an optional large capacity tray which holds 3,000 sheets of copy paper. The machine can also be equipped with an optional finisher to provide finished copy sets ready for distribution.

These copiers were also designed with ease of use in mind. The easy-to-understand operation panel with touch panel system and INFORMATION function will guide the user through most operations. In order to gain the maximum benefit of all the features of the copiers, it is recommended that users first read this manual to become familiar with all the features of the copiers.

NOTE:

- The tandem copying function is not available for the AR-287.
- This manual describes only copier features. For a description of optional printer features and scanner features, see the separate relevant manual.
- The illustrations in this manual are mainly drawn for the AR-407.

USING THIS MANUAL

This manual is intended as an operation guide for both general users and key operators.

For General Users

It is recommended that you read the GETTING STARTED, MAKING COPIES, and SPECIAL FUNCTIONS sections to become familiar with the available features and functions of your copier. Then refer to the manual as needed to become thoroughly familiar with those features you will normally use.

For Key Operators

Please read all sections thoroughly to become familiar with all features and functions of your copier. Throughout the manual, information which is relevant to key operator functions is noted by "★ **KEY OPERATOR**." Please pay close attention to these notes and to the SUPPLIES, COPIER TROUBLE?, GENERAL INFORMATION, and OPTIONAL EQUIPMENT sections so you can ensure smooth and efficient operation of your machine.

A separate KEY OPERATOR'S GUIDE has been written especially for you. It contains the programs and programming information that will enable you to tailor functions for maximum benefit to your company.

CHAPTER 1

GETTING STARTED

This chapter describes the basic information on the use of this copier.

	Page
• INSTALLATION REQUIREMENTS	1-2
• CAUTIONS	1-3
• POWER ON AND OFF	1-5
Power save modes	1-5
• INFORMATION FUNCTION	1-7
• USING THE TOUCH PANEL	1-8
How to use the touch panel	1-8
Selection of function	1-8
Function setting icons	1-9

INSTALLATION REQUIREMENTS

To ensure safety and proper machine performance, please note the following before initial installation and whenever the machine is to be relocated.

1. The copier should be installed near an accessible power outlet for easy connection.
2. Be sure to connect the power cord only to a power outlet that meets the specified voltage and current requirements. Also make certain the outlet is properly grounded.
3. Do not install the machine where it is:
 - damp or humid,
 - exposed to direct sunlight,
 - extremely dusty,
 - poorly ventilated,
 - subject to extreme temperature or humidity changes (e.g., near an air conditioner or heater).
4. Since a hard disk drive is built into this copier, place the copier on a firm, level surface. Choose an area which is not subject to any vibration.
5. Be sure to allow the required space around the machine for servicing and proper ventilation.

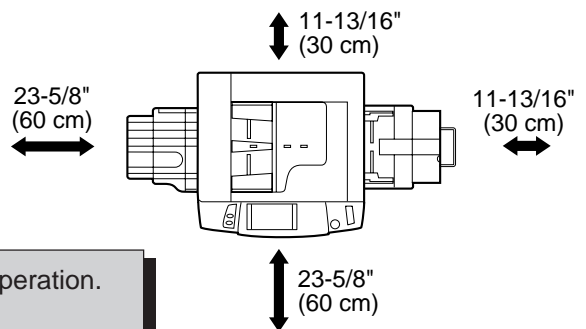
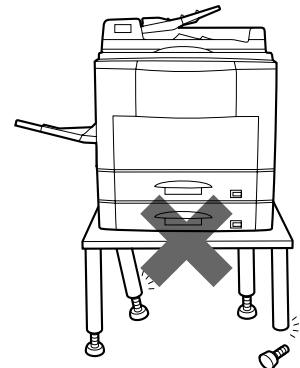
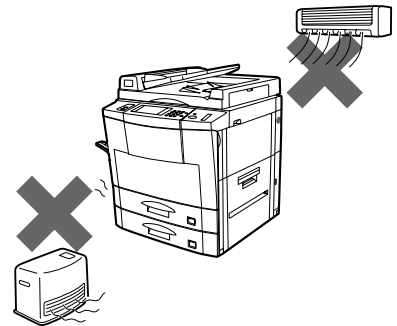
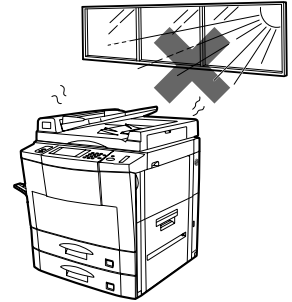

A small amount of ozone is produced within the copier during operation. The emission level is insufficient to cause any health hazard.

NOTE:

The present recommended long term exposure limit for ozone is 0.1 ppm (0.2 mg/m³) calculated as an 8 hr. time-weighted average concentration. However, since the small amount that is emitted may have an objectionable odor, it is advisable to place the copier in a ventilated area.

CAUTIONS

1. Do not touch the photoconductive drum. Scratches or smudges on the drum will cause dirty copies.
2. The fusing unit is extremely hot. Exercise care in this area.
3. Since a hard disk drive is built into the copier, be sure to turn the power switch to the "OFF" position when moving the copier. Take care not to subject the copier to any vibration or shock.
4. Do not look directly at the light source. Doing so may damage your eyes.
5. Four installation adjusters are provided on the optional stand/500-sheet paper drawer. When moving the machine with the optional stand/500-sheet paper drawer, be sure to raise the installation adjusters. After moving the machine, lower the four installation adjusters until they reach the floor and lock the two casters at the front of the copier.
6. When copying is interrupted (for example, because the INTERRUPT function has been used, paper or toner has run out, a misfeed has occurred, etc.), this copier will store the image data of the originals read prior to the interruption. If copying of secret documents is interrupted due to the above reasons, be sure to either resume the interrupted copying by pressing the START key, or clear the image data by pressing the CLEAR ALL key after the interrupt copying is completed or the trouble is cleared, because the stored data may be printed by other operators.

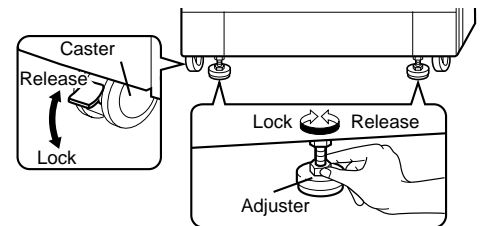
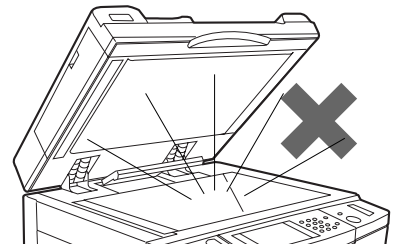
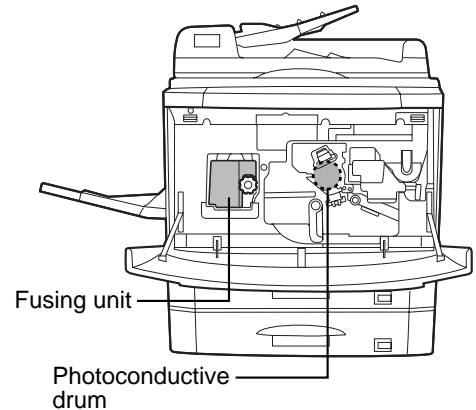

"BATTERY DISPOSAL"
CONTAINS MANGANESE DIOXIDE LITHIUM BATTERY.
MUST BE DISPOSED OF PROPERLY. CONTACT YOUR
SHARP DEALER OR SERVICER FOR INSTRUCTIONS.

Cautions on laser

Wave length	785 nm +10 nm -15 nm
Pulse times	(2.274 μs ±2.3 ns)/7 mm
Output power	0.24 mW - 0.60 mW

SAFETY PRECAUTIONS

This Digital Copier is rated Class 1 and complies with 21 CFR 1040.10 and 1040.11 of the CDRH standards. This means that the copier does not produce hazardous laser radiation. For your safety, observe the precautions below.

- Do not remove the cabinet, operation panel or any other covers.
- The copier's exterior covers contain several safety interlock switches. Do not bypass any safety interlock by inserting wedges or other items into switch slots.

Caution

Use of controls or adjustments or performance of procedures other than those specified herein may result in hazardous radiation exposure.

POWER ON AND OFF

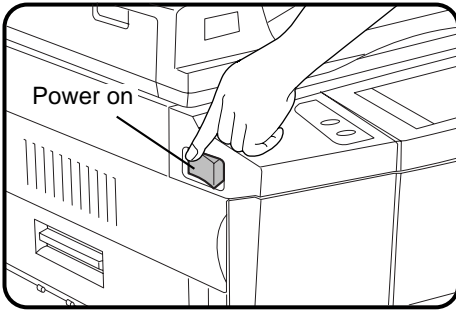

The power switch is located on the left side of the copier. When the power switch is turned to the "ON" position, the message "WARMING UP. PLEASE WAIT." will appear in the message display. Warming up takes about 65 seconds for the AR-287/337 and about 75 seconds for the AR-407. Once the copier is ready, the message display will change to "READY TO COPY.", and the START key indicator will light up, indicating that copying is possible.

If the copier has been programmed in the auditing mode, the message "ENTER YOUR ACCOUNT NUMBER. -----" will appear after warming up. Once a valid account number has been entered, copying will become possible.

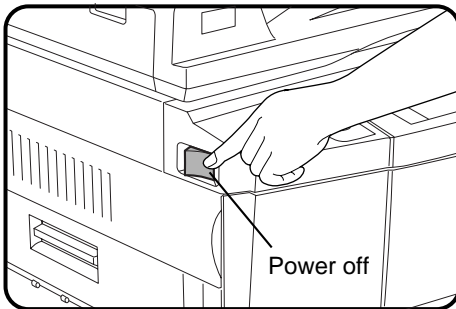

Power save modes

The copier has two power save modes to reduce overall power consumption and thereby reduce the cost of operation and to conserve natural resources to help reduce environmental pollution. The two power save modes are preheat mode and auto power shut-off mode.

★ KEY OPERATOR

The preheat activation time and the auto power shut-off time have been preset at the factory to 15 min. for preheat mode and 60 min. for auto power shut-off mode. These times can be changed as described in the key operator's guide. It is suggested that you set appropriate times according to the actual usage of the copier.

Auto power shut-off mode

If the auto power shut-off mode is enabled, the copier will automatically turn off the power once a programmed length of time has elapsed without any copier operation after the last copy of a run is made or the power is first turned on. The power switch will automatically be turned to the "OFF" position.

To turn the power back on, simply turn the power switch to the "ON" position.

★ **KEY OPERATOR** See page 21 of the **KEY OPERATOR'S GUIDE** for setting the auto power shut-off timer. See page 27 of the **KEY OPERATOR'S GUIDE** for enabling or disabling the auto power shut-off mode.

Preheat mode

The copier will enter the mode once the set time has elapsed without any copier operation after the last copy of a run is made or power is turned on.

When the copier enters the preheat mode, the message "**PREHEAT MODE. PLACE ORIGINALS.**" will appear.

In this condition, the fuser in the copier is maintained at a lower heat level thereby saving power. The preheat level is, however, high enough to allow the copier to come to a ready condition or begin copying approximately 30 seconds after any key input is made.

To copy from the preheat mode, make desired copier selections and press the START key using the normal copying procedure.

★ **KEY OPERATOR** See page 22 of the **KEY OPERATOR'S GUIDE** for information on setting the preheat mode.

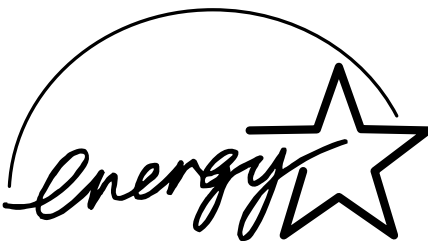

As an ENERGY STAR® Partner, SHARP has determined that this product meets the ENERGY STAR® guidelines for energy efficiency.

INFORMATION FUNCTION

The information function provides a quick reference guide to the use of the various features and functions of this copier. The information mode can be entered when the copier is in the standby mode.

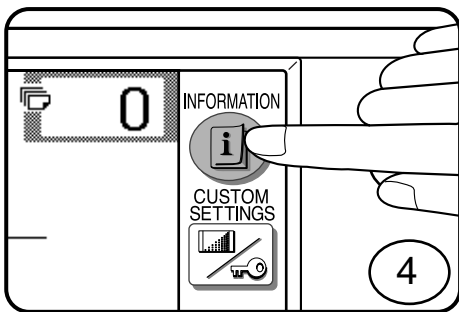

- 1 Press the INFORMATION (i) key in the standby mode.**
 - The screen for the information categories will appear.

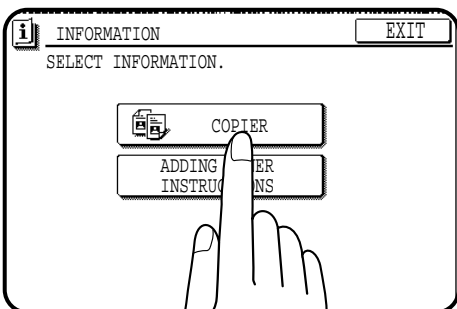

- 2 Select the "COPIER" key to display the first screen of the copier feature items.**
 - If the toner supply is not low, this screen is not displayed. Proceed to step 3.

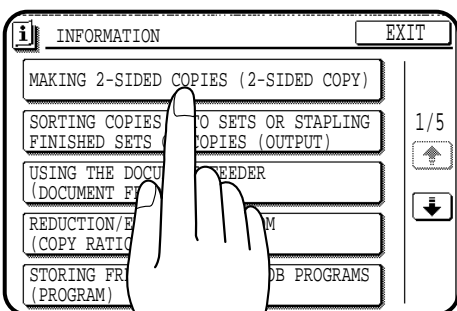

- 3 Select the feature you would like to know about by pressing a copier feature item key on the touch panel.**
 - If the feature you would like to know about is not displayed on the touch panel, press the scroll (↓) key on the touch panel until the feature is displayed.
 - If a copier feature item key is pressed, the description for that feature will appear. Use the scroll (↓) key to display additional information until all information for that feature has been displayed.
 - To return to the copier feature item screen, press the "INDEX" key.
 - To exit the INFORMATION mode, press the "EXIT" key on the touch panel.

USING THE TOUCH PANEL

How to use the touch panel

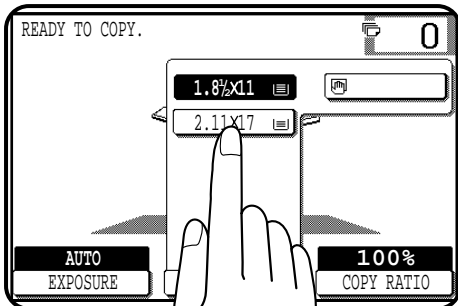

You can set or cancel a function displayed on the touch panel by pressing (touching) a key with a finger. The touch key operation can be confirmed with a beep tone (and highlighted display).

★ **KEY OPERATOR** For the beep tone to be heard, the beep tone must be enabled by a key operator program. See page 27 of the **KEY OPERATOR'S GUIDE**.

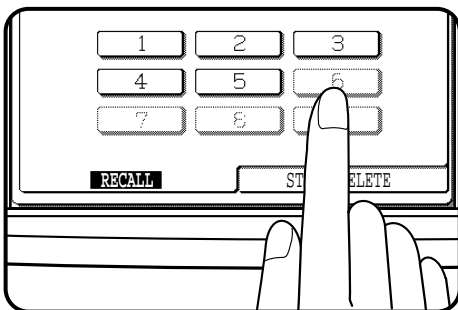

If any keys are displayed gray, the keys have been disabled. If you press these keys, two short beeps will be sounded.

Selection of function

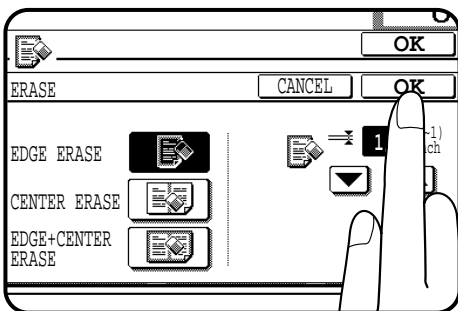

To register the selected settings for a function, press the "OK" key on the setting screen. The settings indicated by a highlighted display will be registered as a selected function.

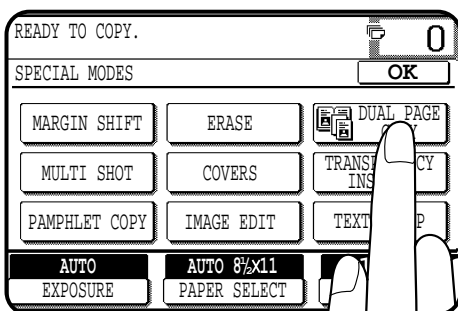

Some special functions can be selected by pressing the relevant keys on the **SPECIAL MODES** screen (page 3-4) or on the **IMAGE EDIT** menu (page 3-21) to highlight the keys. To cancel these functions, press the relevant keys again to return the keys to the normal display. These functions are: Dual page copying, Centering, B/W reverse, and Binding change.

Function setting icons

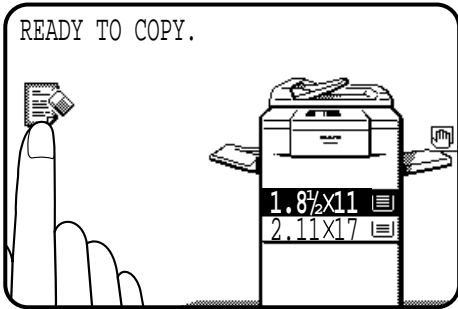

Selected special functions are indicated with their icons on the basic screen. The setting screen for a selected function can be easily called by pressing its icon. If multiple special functions are selected, up to six icons will be displayed.

The function setting icons are listed below. The content of the icons indicated by *1 will change depending upon the particular settings for these functions.

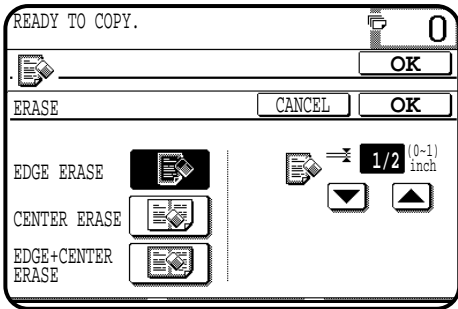

*1 Margin shift (p.3-4)



*1 Repeat copy (p.3-24)



*1 Erase (p.3-6)



B/W reverse (p.3-27)



Dual page copying (p.3-8)



Binding change (p.3-29)



*1 Multi shot (p.3-10)



Date (p.3-32)



*1 Covers (p.3-13)



Select stamp (p.3-35)



*1 Transparency film with insert sheets (p.3-15)



Watermark (p.3-38)



Pamphlet copy (p.3-17)



Page number (p.3-41)



Job build (p.3-20)



Tandem copy (p.3-44)



Centering (p.3-22)

CHAPTER 2

MAKING COPIES

This chapter describes the basic copying functions such as normal copying, reduction/enlargement, and exposure adjustments.

	Page
• AUDITING ACCOUNTS	2-2
• USING THE RSPF	2-3
• COPYING FROM THE DOCUMENT GLASS	2-8
• REDUCTION/ENLARGEMENT/ZOOM	2-11
• SPECIAL PAPERS (manual feed)	2-14
Two sided copying with bypass tray	2-15
• EXPOSURE ADJUSTMENTS	2-16
• SORT/GROUP	2-17
• JOB MEMORY	2-18
• INTERRUPTING A COPY RUN	2-20

AUDITING ACCOUNTS

If this copier has been programmed in the auditing mode, it will not function until an assigned 5-digit account number has been entered.

★ **KEY OPERATOR** See page 9 of the **KEY OPERATOR'S GUIDE** for setting the auditing mode.

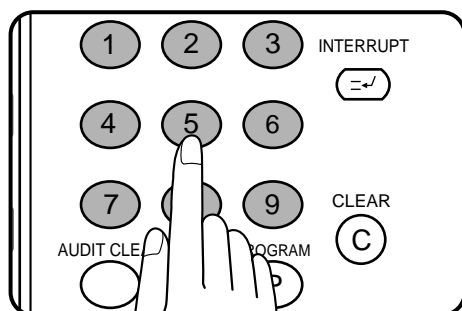

The initial status of the message display will be:

```
ENTER YOUR ACCOUNT NUMBER. -----
```

- Enter your account number using the 10-key pad.
- As each digit is entered, the dashes in the display will change to asterisks.

The following message will appear after the number is entered.

```
ACCOUNT STATUS: COPIES MADE 000,000  
COPIES REMAINING 000,000
```

“COPIES REMAINING” will appear only if account limit has been set using a key operator program.

★ **KEY OPERATOR** See page 12 of the **KEY OPERATOR'S GUIDE** for account limit settings.

The message, however, will not be displayed when the printer auditing mode is enabled by the key operator program with the optional printer expansion kit installed. Then the account limit setting will be canceled.

★ **KEY OPERATOR** See page 46 of the **AR-PB2A operation manual** for the printer auditing mode setting.

- The message will be displayed for several seconds, then change to the following message.

```
READY TO COPY.
```

- When a copy run is performed, the following message will appear.

```
READY TO COPY.  
PRESS [AUDIT CLEAR] WHEN FINISHED.
```

- In the interrupt copy mode (see page 2-20), the following message will appear instead of the message above.

```
READY TO COPY. WHEN COPYING IS  
FINISHED, PRESS [INTERRUPT].
```

NOTE:

If an unassigned number is entered, the message display will show “ENTER YOUR ACCOUNT NUMBER. -----”, indicating that the number was not accepted.

When the key operator program of account number security has been set:

If an unassigned number is entered three successive times, the copier will not accept another number for one minute, and the following message will appear.

```
PLEASE SEE YOUR KEY OPERATOR FOR  
ASSISTANCE.
```

★ **KEY OPERATOR** See page 13 of the **KEY OPERATOR'S GUIDE** for account number security.

USING THE RADF

The RADF (reversing automatic document feeder) will handle multiple originals.

- Before loading originals into the document feeder tray, be sure to remove any staples or paper clips from them.
- Damaged or crumpled originals or originals which have been folded may misfeed in the RADF or cause incorrect size detection. It is recommended that these be copied from the document glass and the copies be used as original documents.
- When feeding originals which have closely spaced binding holes punched along an edge, place the originals so that the punched edge is positioned to the right or along the side guides.
- Special originals such as transparency film and tracing paper should not be fed from the RADF, but should be placed on the document glass.
- Duplex copying will not work when a non-standard sized paper or 5-1/2" x 8-1/2" paper is used.
- If the orientation of the originals does not match that of the copy paper when both the originals and copy paper are of standard sizes and the auto paper select mode or automatic copy ratio select mode is on, the image of the originals will be automatically rotated to match the copy paper. However, if enlargement copying onto a paper size larger than 8-1/2" x 11" is performed, the image will not be rotated.
- Image loss (max. 13/64" (5 mm)) can occur along the leading and trailing edges of the copies. Also image loss (max. 13/64" (5 mm) in total) can occur along the other edges of the copies.
- The RADF can handle a maximum of 50 originals of 5-1/2" x 8-1/2" to 8-1/2" x 11" sizes and 30 originals of 8-1/2" x 14" to 11" x 17" sizes.
- 2-sided to 1-sided copying and 2-sided to 2-sided copying can be performed in these models.
- The originals must be set face up in the document feeder tray.
- Different size originals with the same width can be placed in the document feeder tray and automatically copied onto copy paper of their respective sizes. The automatic copy ratio selection will not function in this case.

Stream feeding mode

If the stream feeding mode has been enabled using a key operator program, the message "**NEWLY PLACED ORIGINALS WILL BE FED AND COPIED AUTOMATICALLY.**" will appear and the original feed indicator will continue to blink for approximately 5 seconds after feeding of all originals is completed. While this message is displayed, any new originals placed in the document feeder tray will be fed and copied automatically.

★ **KEY OPERATOR** See page 17 of the **KEY OPERATOR'S GUIDE** for information on setting the stream feeding mode.

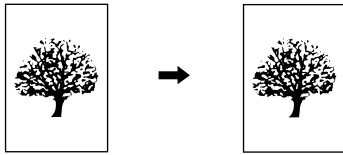

1-sided copies of 1-sided originals

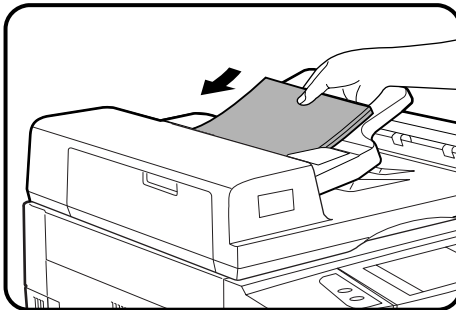
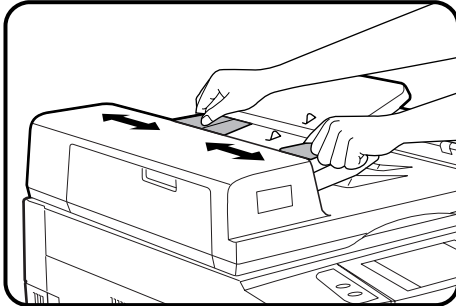

1 Adjust the original guides to the size of the originals and set the originals face up in the document feeder tray.

- The original size will be indicated on the touch panel, and the paper tray with the corresponding paper size will be automatically selected.
- Be sure to remove any original from the document glass before setting the originals in the document feeder tray. If an original is left on the document glass, the original reminder indicator will blink. Remove the original from the document glass in this case.
- If copy paper of the required size is not installed in any of the trays, the following message will appear.

LOAD □□" x □□" PAPER.

If a tray of the required size is not installed, use the bypass tray and press the "PAPER SELECT" key on the touch panel to select the bypass tray.

- To copy onto a different size paper, use the "PAPER SELECT" key to make the selection.

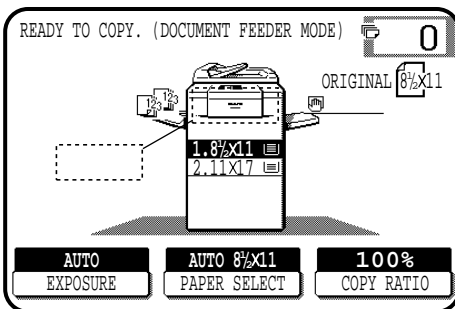

2 Ensure that the 1-sided to 1-sided copying mode is selected on the touch panel.

- When no icon is displayed in the area indicated in the illustration (), the 1-sided to 1-sided copying mode is selected.
- If the 1-sided to 1-sided mode is not selected, press the 2-SIDED COPY key and then press the 1-sided to 1-sided key () on the touch panel. Press the "OK" key to return to the basic screen.

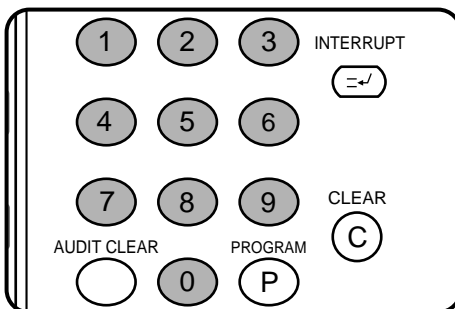

3 Use the 10-key pad to enter the desired number of copies.

- The number will be shown in the copy quantity display of the touch panel.
- Use the CLEAR (C) key to cancel an entry if a mistake has been made.
- If you set a multiple number of copies, the copies will be delivered collated. To deliver in the GROUP mode, press the OUTPUT key and then select "GROUP" on the touch panel. See page 2-17.

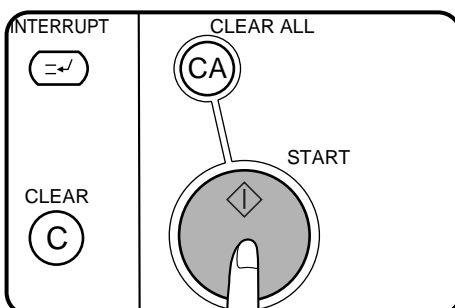

4 Press the START key.

- To cancel a copy run, press the CLEAR ALL (CA) key. Copying will stop and the RADF will output any originals which have been fed. Also, the number in the copy quantity display will be reset to 0.

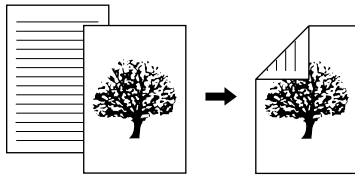

2-sided copies from 1-sided originals

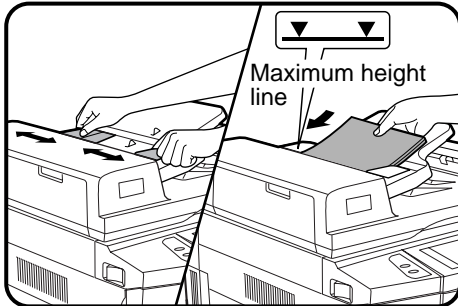

1 Adjust the original guides to the size of the originals and set the originals face up in the document feeder tray.

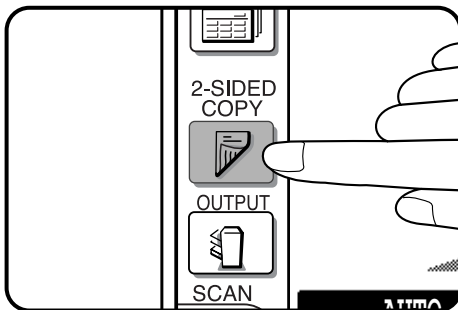

2 Press the 2-SIDED COPY key.

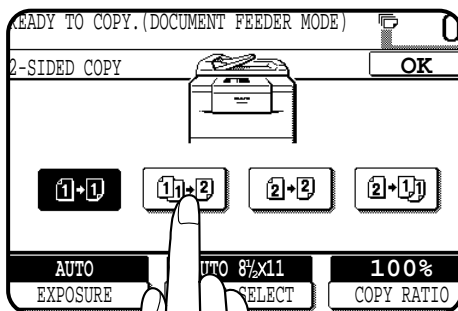

3 Press the **1j+2** key on the touch panel.

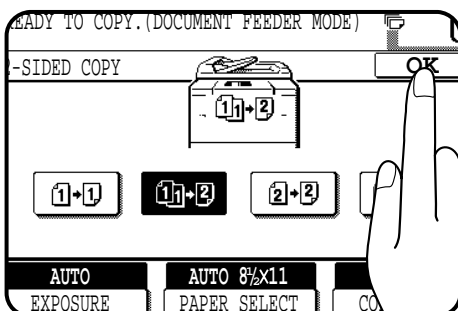

4 Press the "OK" key.

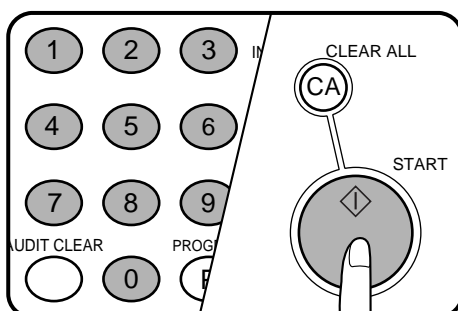

5 Enter the desired number of copies.

6 Press the START key.

- To cancel a copy run during duplex copying, press the CLEAR ALL (CA) key.

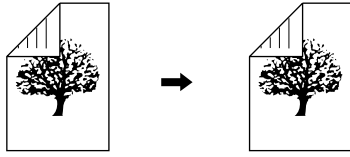

2-sided copies from 2-sided originals

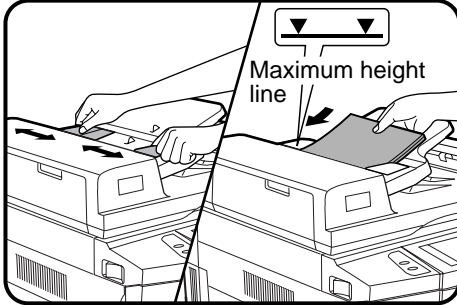

1 Adjust the original guides to the size of the originals and set the originals face up in the document feeder tray.

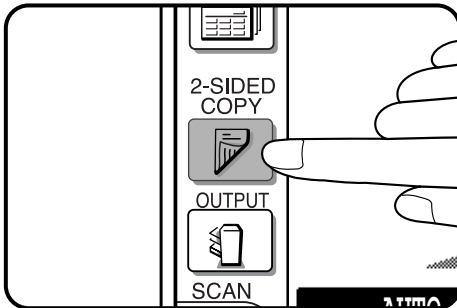

2 Press the 2-SIDED COPY key.

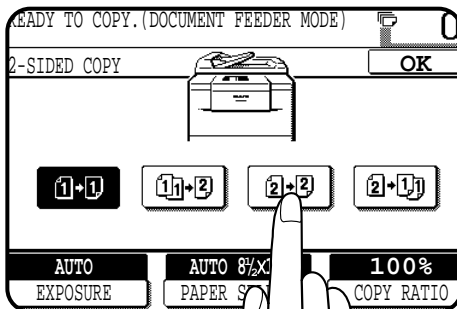

3 Press the **2+2** key on the touch panel.

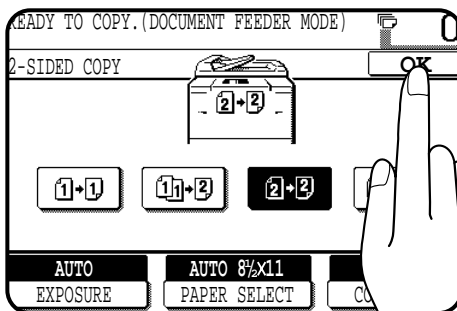

4 Press the "OK" key.

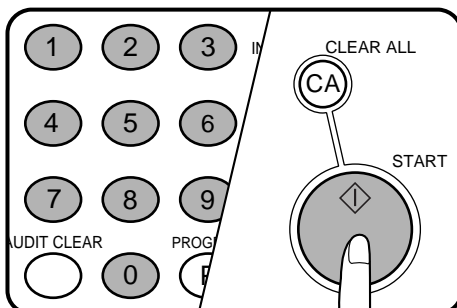

5 Enter the desired number of copies.

6 Press the **START** key.

- To cancel a copy run during duplex copying, press the CLEAR ALL (CA) key.

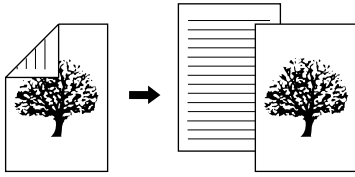

1-sided copies from 2-sided originals

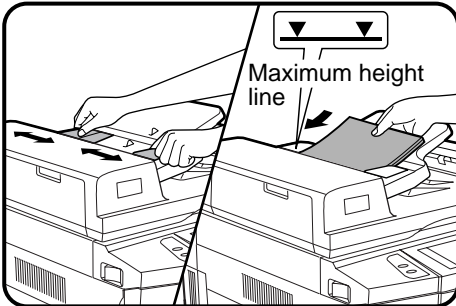

1 Adjust the original guides to the size of the originals and set the originals face up in the document feeder tray.

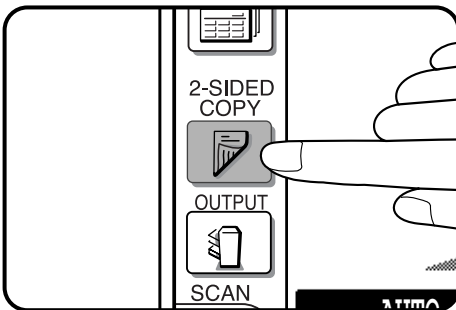

2 Press the 2-SIDED COPY key.

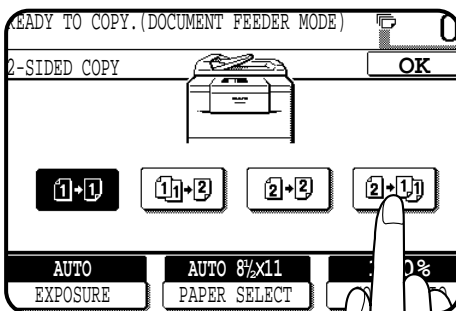

3 Press the  key on the touch panel.

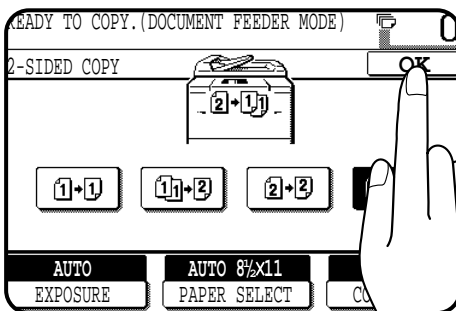

4 Press the "OK" key.

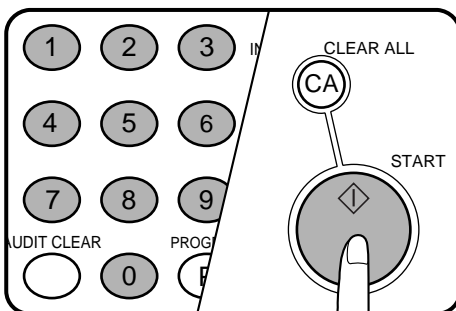

5 Enter the desired number of copies.

6 Press the START key.

- To cancel a copy run, press the CLEAR ALL (CA) key. Copying will stop and the RADF will output any originals which have been fed. Also, the number in the copy quantity display will be reset to 0.

COPYING FROM THE DOCUMENT GLASS

Use the document glass for copying single originals, bound documents, and other originals that cannot be set in the RADF.

- Only 1-sided to 1-sided and 1-sided to 2-sided copying can be selected when copying from the document glass.
- Duplex copying will not work when a non-standard sized paper or 5-1/2" x 8-1/2" paper is used.
- 2-sided to 2-sided or 2-sided to 1-sided copying cannot be selected when copying from the document glass. These operations can, however, be performed simply by turning over the original manually.
- If the orientation of the original does not match that of the copy paper when both the original and copy paper are of standard sizes and the auto paper select mode or automatic copy ratio select mode is on, the image of the original will be automatically rotated to match the copy paper. However, if enlargement copying onto a paper size larger than 8-1/2" x 11" is performed, the image will not be rotated.
- Image void (max. 13/64" (5 mm)) can occur along the leading and trailing edges of the copies. Also image void (max. 13/64" (5 mm) in total) can occur along the other edges of the copies.

1-sided copies of 1-sided originals

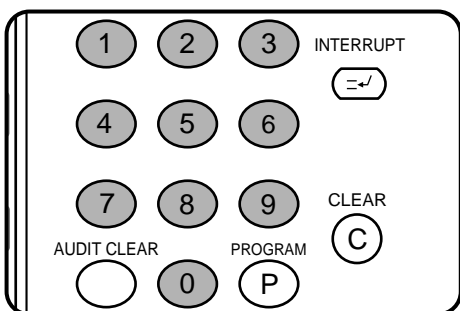
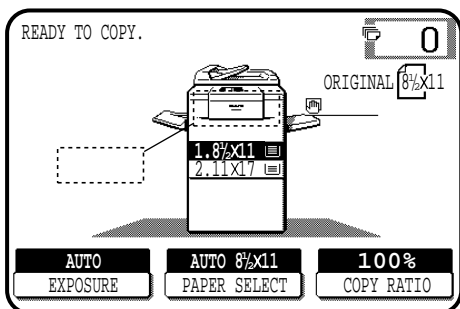
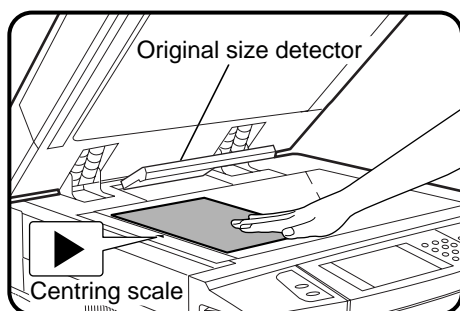

- 1 **Open the document feeder cover and place an original face down on the document glass, using the centering scale to position it.**

- When copying multi-page documents, copy from the last page to the first page.

NOTE:

Do not place objects under the original size detector, because they may damage it.

- 2 **Close the document feeder cover.**
- The original size will be indicated on the touch panel, and the paper tray with the corresponding paper size will be automatically selected.

- 3 **Ensure that the 1-sided to 1-sided copying mode is selected on the touch panel.**

- When no icon is displayed in the area indicated in the illustration (), the 1-sided to 1-sided copying mode is selected.
- If the 1-sided to 1-sided mode is not selected, press the 2-SIDED COPY key and then press the 1-sided to 1-sided key () on the touch panel. Press the "OK" key to return to the basic screen.

- 4 **Use the 10-key pad to enter the desired number of copies.**

- The number will be shown in the copy quantity display of the touch panel.
- A single copy can be made with the initial setting, i.e., when "0" is displayed.
- Use the CLEAR (C) key to cancel an entry if a mistake is made.
- If you set a multiple number of copies, the copies will not be delivered collated in the default setting. To deliver in the SORT mode, press the OUTPUT key and then select the SORT mode on the touch panel. See page 2-17.

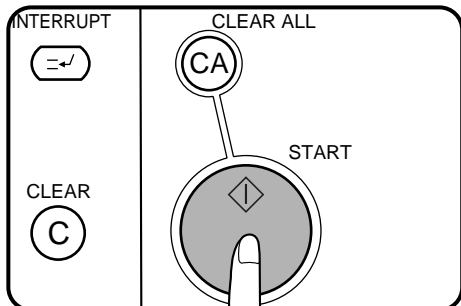

5 Press the START key.

- If the copier is in the GROUP mode (the sort icon is not displayed on the touch panel), copying will start and the number in the copy quantity display will decrease by 1 each time a copy is made. To repeat the same copy sequence with a different original, simply replace the original and press the START key.
- If the copier is in the SORT mode, the original will be scanned when the START key is pressed but copying will not begin. Proceed to step 6.
- To cancel a copy run, press the CLEAR ALL (CA) key. Copying will stop and the number in the copy quantity display will be reset to 0.

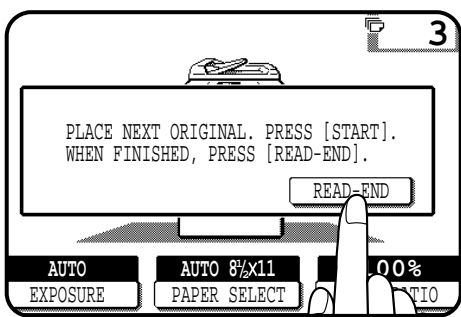

6 Remove the first original with the next original after the START key indicator lights up, and then press the START key. Repeat this step until all the originals have been scanned. Then, press the “READ-END” key on the touch panel.

- Copying will start after the “READ-END” key is pressed.
- Up to 120 sheets of 8-1/2" x 11" originals or up to 60 sheets of originals larger than 8-1/2" x 11" can be scanned.

2-sided copies from 1-sided originals

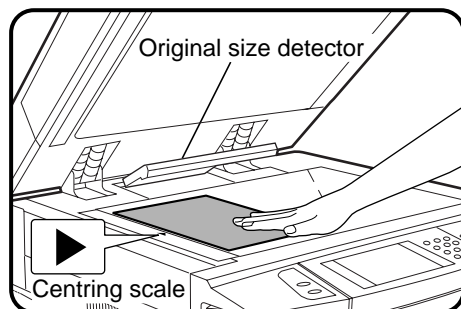

1 Set the last page of the document onto the document glass, using the centering scale to position it.

NOTE:
Do not place objects under the original size detector, because they may damage it.

2 Close the document feeder cover.

- The original size will be indicated on the touch panel, and the paper tray with the corresponding paper size will be automatically selected.

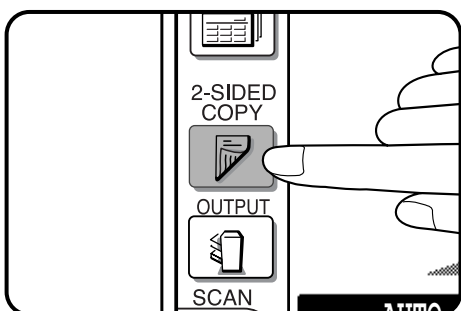

3 Press the 2-SIDED COPY key.

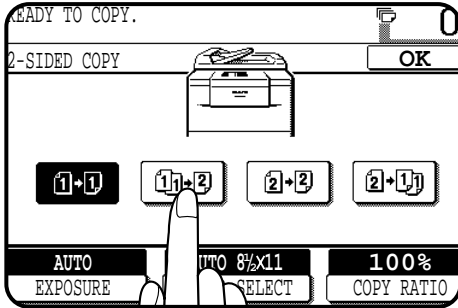

4 Press the  key on the touch panel.

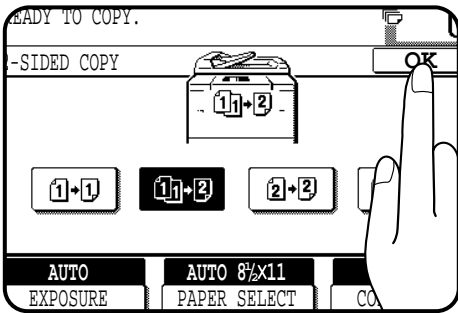

5 Press the “OK” key.

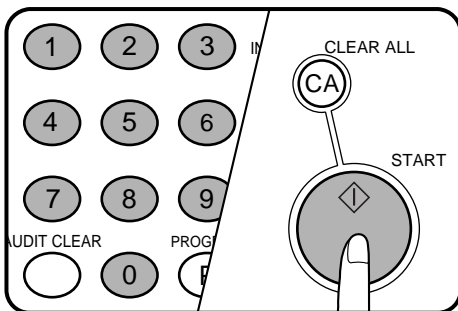

6 Use the 10-key pad to enter the desired number of copies.

- The number will be shown in the copy quantity display.
- Use the CLEAR ((CA)) key to cancel an entry if a mistake is made.

7 Press the **START** key.

- The original will be scanned each time the **START** key is pressed, but copying will not begin yet.

8 Remove the first original and replace it with the next original after the **START** key indicator lights up, and then press the **START** key.

- Copy from the last page to the first page.

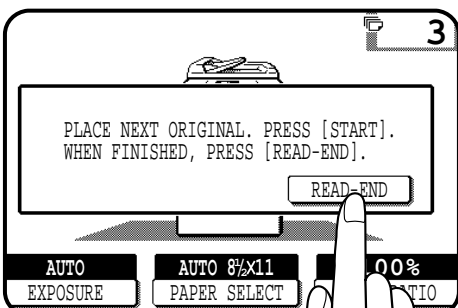

9 Repeat step 8 until all originals have been scanned. Then, press the “READ-END” key on the touch panel.

- Copying will start after the “READ-END” key is pressed. Up to 120 sheets of 8-1/2" x 11" originals or up to 60 sheets of originals larger than 8-1/2" x 11" can be scanned.
- To cancel a copy run, press the CLEAR ALL ((CA)) key.

REDUCTION/ENLARGEMENT/ZOOM

Reduction and enlargement ratios can be selected either automatically with the “AUTO IMAGE” key or manually with the reduction, enlargement or “ZOOM” keys on the touch panel. The zoom function enables precise copy ratio selection from 25% to 400% (for the AR-407) or from 25% to 800% (for the AR-287 and AR-337) in 1% increments.

★ **KEY OPERATOR** A total of four extra preset copy ratios, two each for reduction and enlargement, can be added. See page 15 of the **KEY OPERATOR’S GUIDE**.

- The allowable copy ratio range is limited in the following conditions.
PHOTO MODE/MULTI SHOT/PAMPHLET COPY/REPEAT COPY:
25% to 400%

Automatic selection

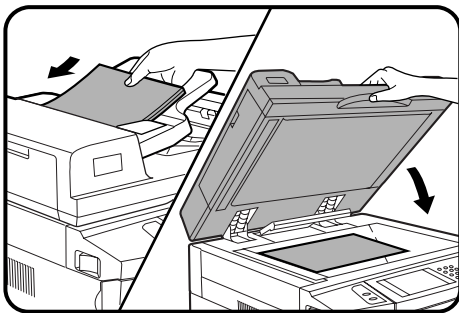

- 1 Place the original in the document feeder tray or on the document glass.**

- The original size will be detected and indicated on the touch panel.

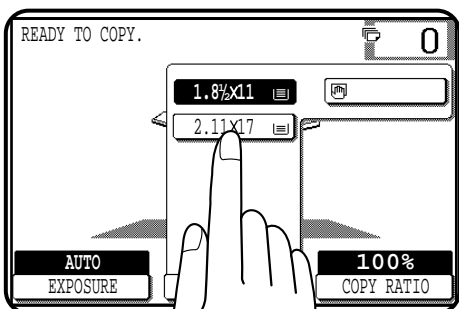

- 2 Press the “PAPER SELECT” key on the touch panel and select the paper tray with the desired paper size.**

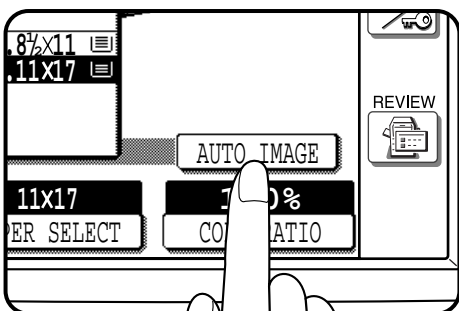

- 3 Press the “AUTO IMAGE” key on the touch panel.**

- The best reduction or enlargement ratio for the selected paper size will be automatically set and displayed on the touch panel.
- If the originals and the selected copy paper are not facing the same direction, the image will be automatically rotated to match the copy paper. However, if enlargement copying onto a paper size larger than 8-1/2" x 11" is performed, the image will not be rotated.

NOTE:

This feature will not work when original or copy paper is of non-standard size.

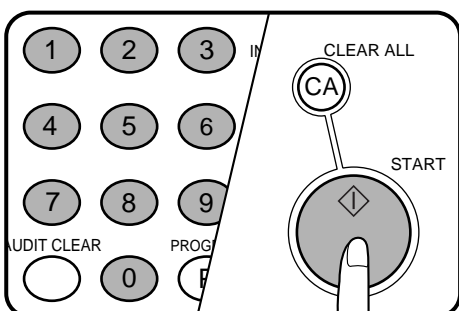

- 4 Enter the desired number of copies.**

- 5 Press the START key.**

- To cancel the automatic reduction/enlargement mode, press the “AUTO IMAGE” key again.

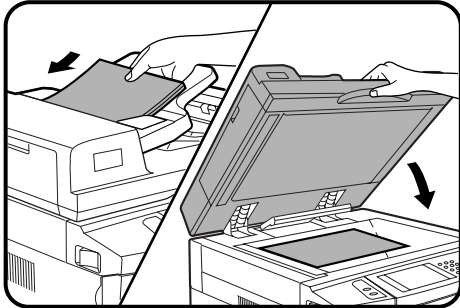

1 Place the original in the document feeder tray or on the document glass.

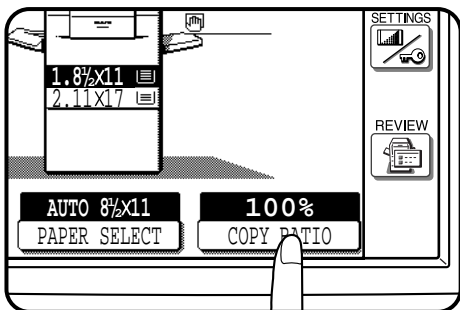

2 Press the “COPY RATIO” key on the touch panel.

MENU 1

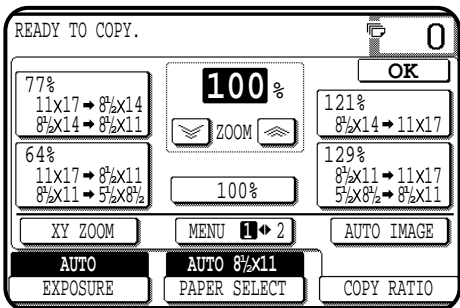

3 Use the **MENU 1 ↔ 2** key to select menu 1 or menu 2 for copy ratio selection.

Menu 1

- A. Preset reduction copy ratios are: 77% and 64%.
- B. Preset enlargement copy ratios are: 121% and 129%.

Menu 2

- A. Preset reduction copy ratios are: 95%, 50%, and 25%.
- B. Preset enlargement copy ratios are: 141%, 200%, and 400% (800% for the AR-287 and AR-337).

MENU 2 (AR-407)

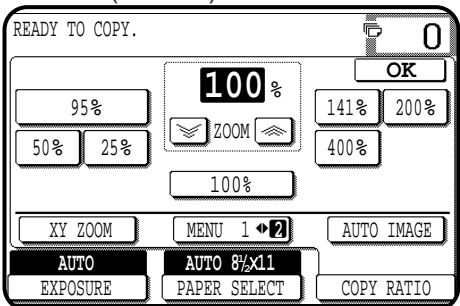

4 Use the reduction, enlargement, and “ZOOM” keys on the touch panel to set the desired copy ratio.

Zoom ratios: Any ratio from 25% to 400% (800% for the AR-287 and AR-337) can be set in 1% increments.

- Press a reduction or enlargement key to set the approximate ratio, then press the key to decrease the ratio or the key to increase the ratio.
- To set the horizontal and vertical copy ratios separately, use the XY ZOOM feature. See page 3-2.
- To reset the copy ratio to 100%, press the “100%” key on the touch panel.
- The message “**IMAGE IS LARGER THAN THE COPY PAPER.**” may appear, indicating that the selected copy ratio is too large for the copy paper size. However, if you press the START key, a copy will be made.
- The image of the original may be rotated to match the copy paper orientation if the original and copy paper are of standard sizes.

MENU 2 (AR-287/AR-337)

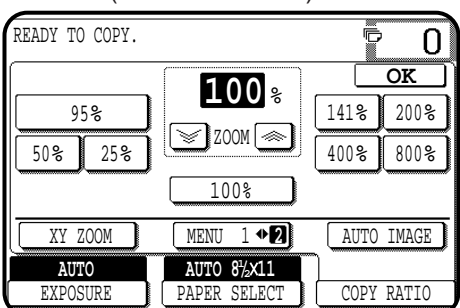

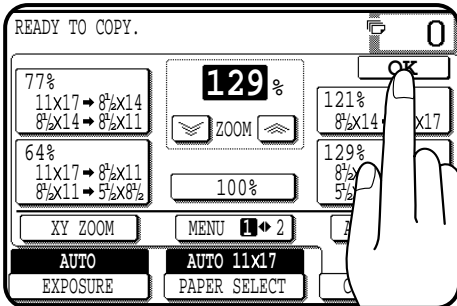

5 Press the “OK” key.

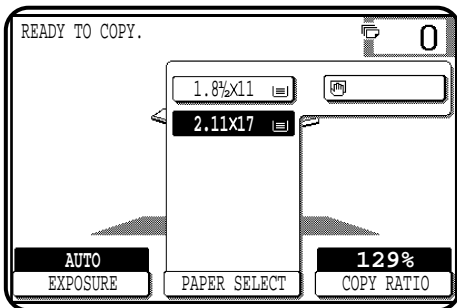

6 Use the “PAPER SELECT” key to select the paper tray with the desired paper size.

- If the AUTO PAPER SELECT mode is on, the appropriate copy paper size will have been automatically selected based on the original size and selected copy ratio.
- If a tray of the required size is not installed, use the bypass tray and press the “PAPER SELECT” key to select the bypass tray.

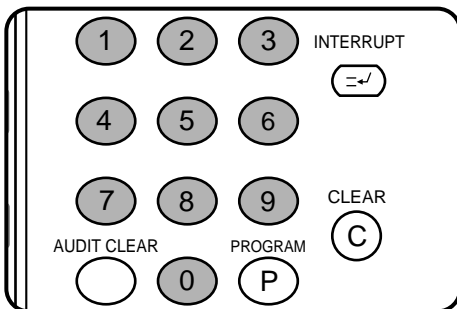

7 Enter the desired number of copies.

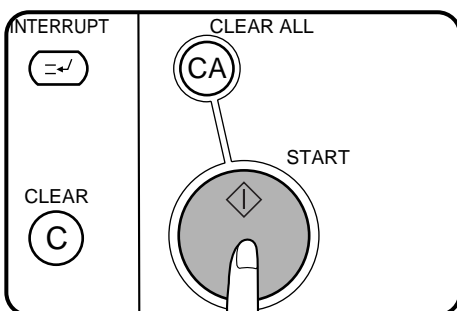

8 Press the START key.

SPECIAL PAPERS (manual feed)

The bypass tray is used to copy onto transparency film, labels, tracing paper, and other special purpose papers. Up to 50 sheets of standard copy paper can be set in the bypass tray.

- Automatic duplex copying will not work when a non-standard sized paper is used. If a duplex copying mode is selected and a non-standard sized paper is used from the bypass tray, the corresponding one-sided mode will be selected automatically when the START key is pressed.

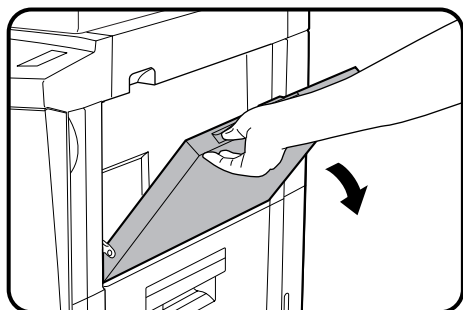

1 Place the original in the document feeder tray or on the document glass.

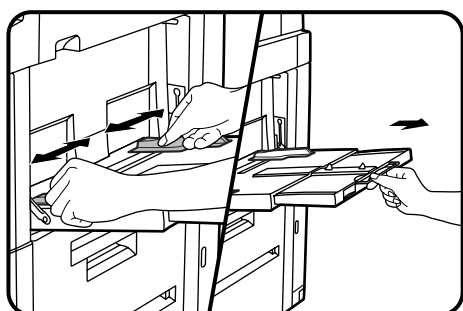

2 Open the bypass tray.

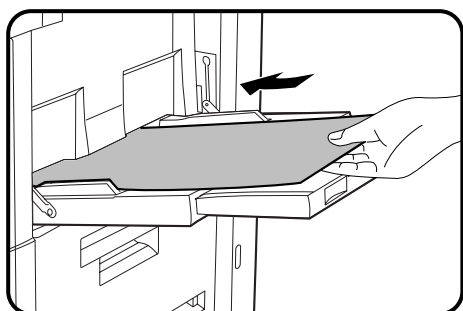

3 Set the bypass tray guides to the width of the copy paper.

- Be sure to extend the tray when feeding 8-1/2" x 11"R, 8-1/2" x 14" or 11" x 17" sized paper. When feeding 11" x 17" sized paper, pull out the metallic support.

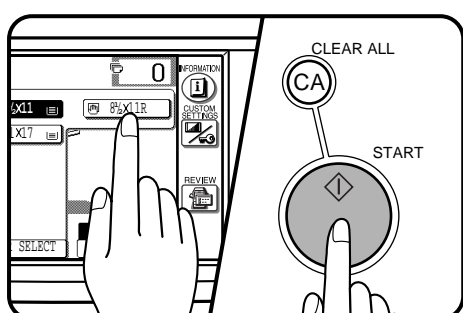

4 Insert the copy paper all the way into the bypass tray.

- Labels, tracing paper, and other special purpose papers other than SHARP recommended transparency film must be fed individually. Multiple sheets of SHARP recommended transparency film can be loaded in the bypass tray.
- Up to 50 sheets of standard copy paper measuring from 5-1/2" x 8-1/2" to 11" x 17" can be loaded into the bypass tray.
- When adding paper, first remove remaining paper, combine it with the paper to be added and then reload as a single stack.

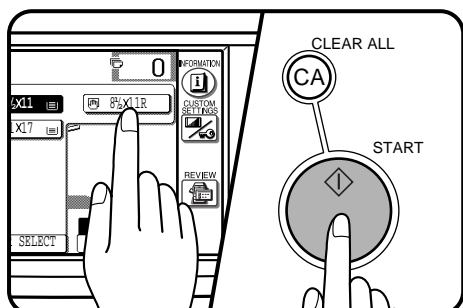

5 Press the "PAPER SELECT" key on the touch panel and then select the bypass tray.

6 Set the number of copies.

7 Press the START key.

Two-sided copying with bypass tray

Two-sided copies can be made manually using the bypass tray, when the heavy paper which is out of spec. for duplex module is used.

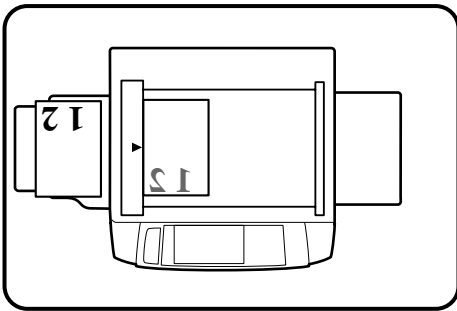

1 Place the first original face down on the document glass and make a copy.

- The first side of the copy can be made using any of the paper feed stations.

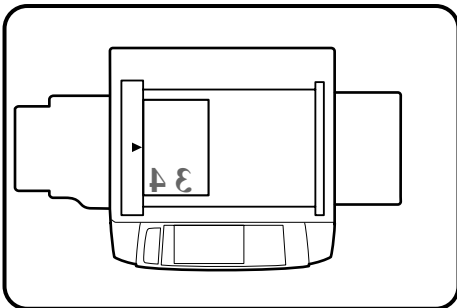

2 Replace the first original with the second original and close the document cover.

- Make sure the first and second originals are oriented in the same way on the document glass.
- The first and second originals can be set in the document feeder tray. However, they must be set individually.

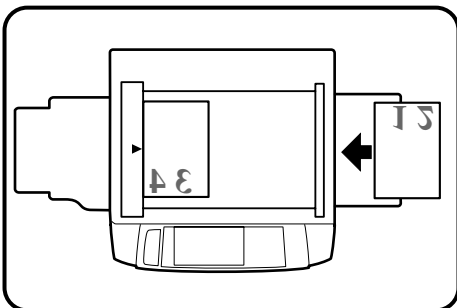

3 Turn the first copy over without changing its top-bottom orientation and place it into the bypass tray.

- Be sure to feed the copies one sheet at a time.

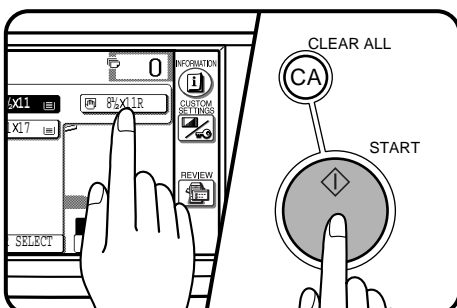

4 Press the "PAPER SELECT" key and select the bypass tray.

5 Press the START key.

EXPOSURE ADJUSTMENTS

This copier has four exposure modes to choose from: AUTOMATIC, TEXT, TEXT/PHOTO and PHOTO.

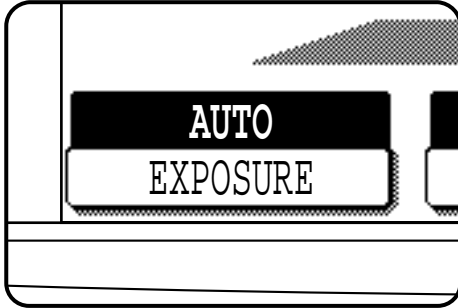

Automatic

This is the standard initial setting for this copier. In this mode, the characteristics of an original being copied are “read” by the exposure system, and exposure adjustments are made automatically. This optimizes the contrast of the copied images by reducing the effect of colored or shaded background areas.

Text, text/photo, and photo

Text mode: This mode is useful in enhancing very low density areas of an original or in suppressing unusually high-density background areas.

Text/photo mode: This mode provides the best balance for copying an original which contains both text and photos. This mode is also useful for copying printed photographs.

Photo mode: This mode provides the best copies of photographs with fine details.

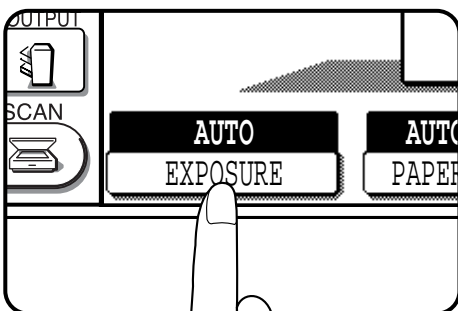

1 Press the “EXPOSURE” key on the touch panel.

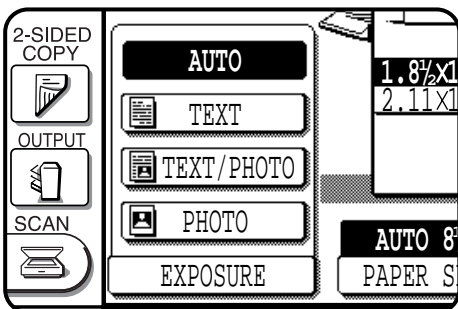

2 Select “TEXT”, “TEXT/PHOTO” or “PHOTO” depending on the original.

NOTE:

When the photo mode is selected, the copy ratio is limited between 25% and 400%.

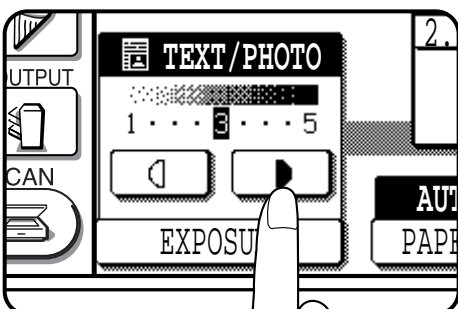

3 Use the  and  keys to adjust the copy density as desired.

SORT/GROUP

When the SORT () icon is indicated on the touch panel, copies will be collated by sets and then delivered to the exit tray.

When the SORT () icon is not indicated, copies will be grouped by originals.

- When the RADF is used for copying, copies will be collated in the default setting. To copy in the GROUP mode, press the OUTPUT key and then select the GROUP mode on the touch panel. When the GROUP mode is selected, the GROUP () icon is indicated on the touch panel.
- When the document glass is used for copying, copies will be grouped. To copy in the SORT mode, press the OUTPUT key and then select the SORT mode on the touch panel.

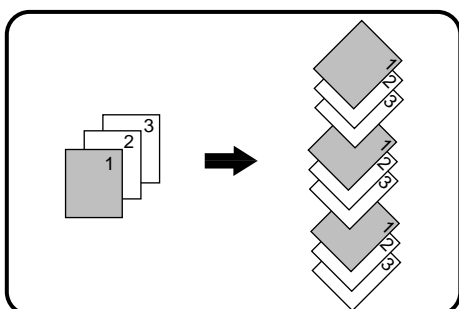

SORT mode

Each set of copies will be sequentially delivered to the exit tray.

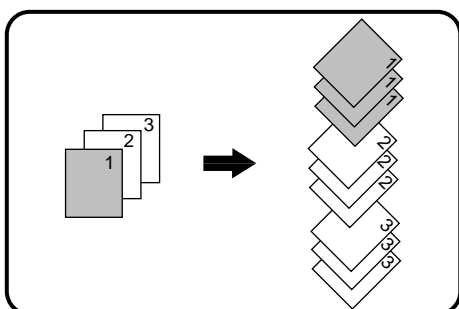

GROUP mode

All copies of the same original will be grouped in the exit tray.

JOB MEMORY

Frequently used job programs can be stored in one of nine storage registers. This is convenient for quick job recall without losing time manually reprogramming each aspect of the job.

- All functions that can be set in the copy mode except the copy quantity setting can be stored in the job memory.
- If any function which has been stored in a job program is modified by a key operator program, the key operator settings will supercede the previous setting.

★ **KEY OPERATOR** Job memory replacement/deletion can be prohibited. See page 25 of the **KEY OPERATOR'S GUIDE**.

Storing a job program

1 Press the PROGRAM key.

- The JOB PROGRAMS screen will appear on the touch panel.

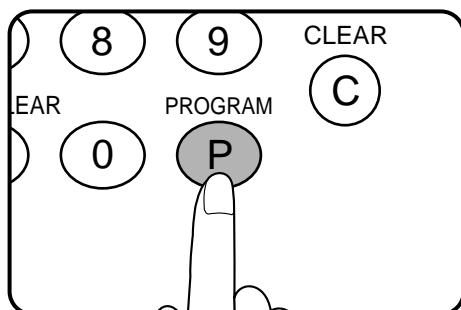

2 Press the "STORE/DELETE" key on the touch panel.

- To cancel the job memory mode, press the "EXIT" key or the CLEAR ALL (CA) key.

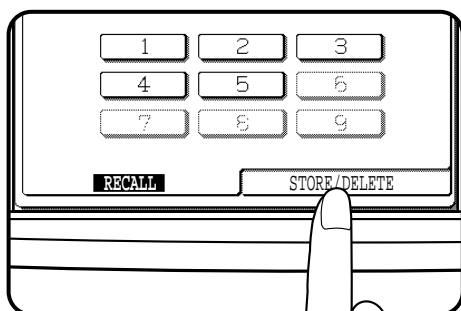

3 Select a program number from 1 to 9 on the touch panel.

- The numbers which are highlighted are program numbers which have been used.
- If a program number which has been used is entered, a message will appear to confirm the selection. To replace with the new program, press the "STORE" key and proceed to the next step. To cancel replacement, press the "CANCEL" key.

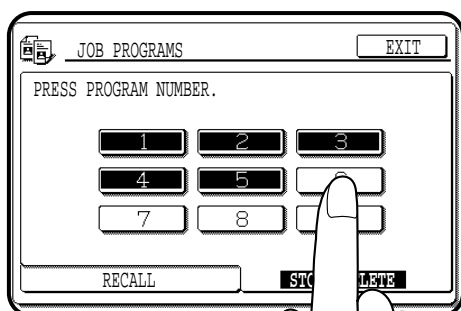

4 Make all copier selections to be stored.

5 Press the "OK" key to complete the storage.

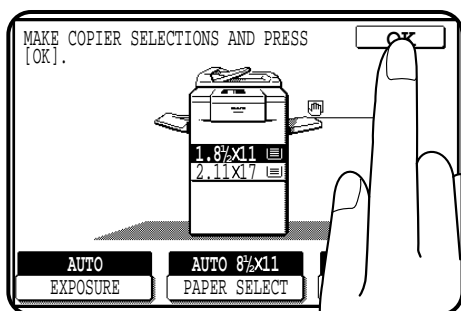

Deleting a stored job program

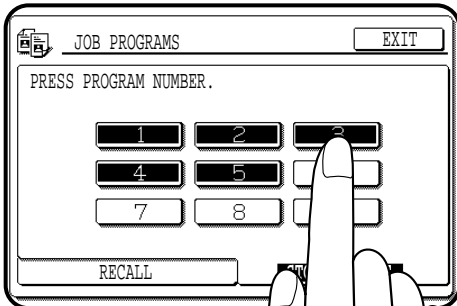

1 Follow steps 1 and 2 in “Storing a job program” on the previous page. (1. Press the PROGRAM key. 2. Press the “STORE/DELETE” key.)

2 Select the storage register number of the program to be deleted.

- Be sure to select a number which contains a stored program. If not, “Storing a job program” operation will start.

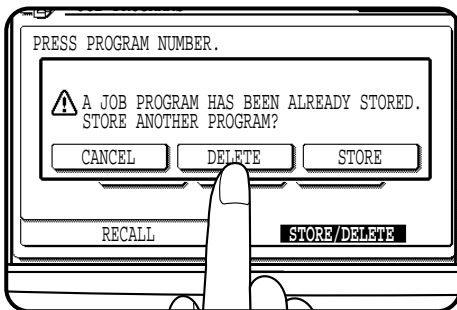

3 Press the “DELETE” key.

- The program will be deleted from memory.
- To cancel deletion, press the “CANCEL” key.

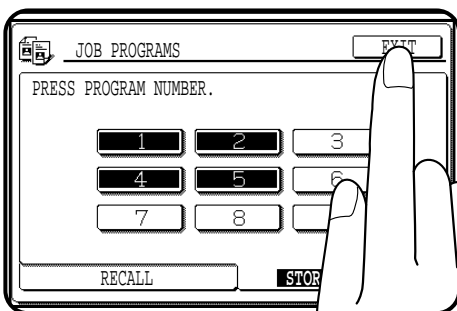

4 Press the “EXIT” key to exit the job memory mode.

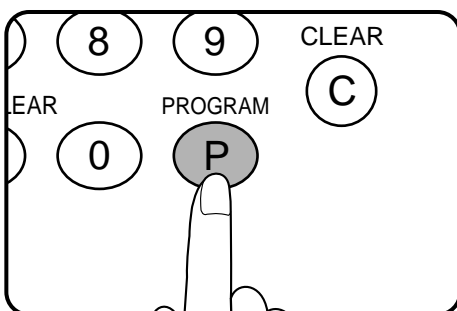

Recalling a job program

1 Press the PROGRAM key.

- The JOB PROGRAMS screen will appear on the touch panel.
- The numbers which are indicated are program numbers which contain stored programs.

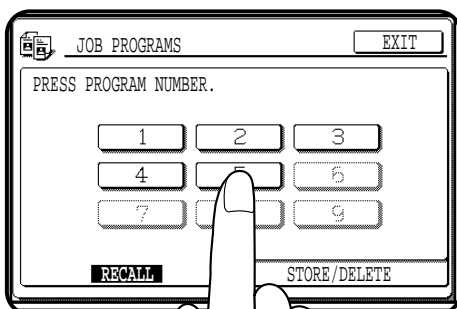

2 Select a stored program from 1 to 9 on the touch panel.

- All selections stored in the program will appear on the touch panel.
- The recalled settings may be modified for a particular job run, but any changes made will not be stored in the job memory. To store the new settings, follow the “Storing a job program” procedure.

INTERRUPTING A COPY RUN

INTERRUPT can be used to temporarily stop a long copy run so that another job can be run.

- INTERRUPT will not function during duplex copying.
 - Duplex copying, tandem copying and the JOB BUILD function can not be selected during interrupt copying.
 - When an optional dual tray output unit (AR-TR1) is installed, interrupt copies are output to the second tray of the unit.
- ★ **KEY OPERATOR** *If the second tray is not installed, output of copies to the second tray must be disabled. See page 27 of the KEY OPERATOR'S GUIDE.*

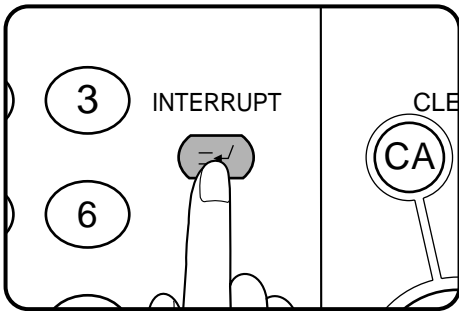

1 Press the INTERRUPT key.

- When the document feeder is being used, the copier will stop after completing the copying of the originals which have been fed into the document feeder. The INTERRUPT indicator will blink until the copier becomes ready for interrupt copying. Then the INTERRUPT indicator will light up. The copier will return to the initial setting.
- If the copier has been programmed in the auditing mode, the account number entry message will appear. Enter your account number using the 10-key pad. The number of copies of the interrupt copying will be accumulated against this account number.

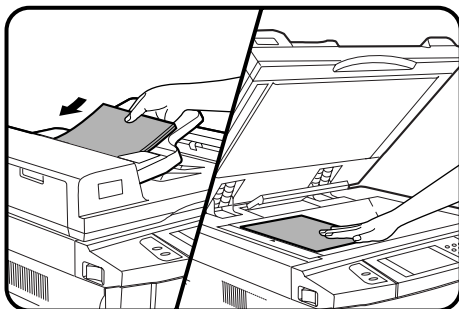

2 When the copier stops, remove the original(s) and set the original(s) for interrupt copying in the document feeder tray or on the document glass.

- The maximum number of originals for interrupt copying is restricted.
 - 1-sided originals: 20 sheets (10 sheets for 8-1/2" x 14" and 11" x 17")
 - 2-sided originals: 10 sheets (5 sheets for 8-1/2" x 14" and 11" x 17")

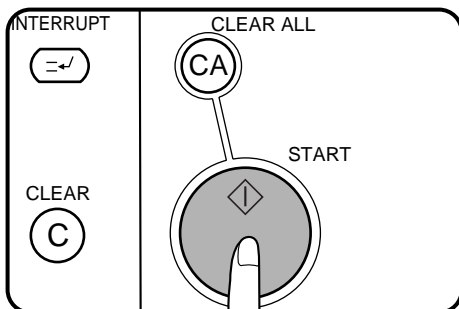

3 Select the desired available copier functions.

4 Press the START key.

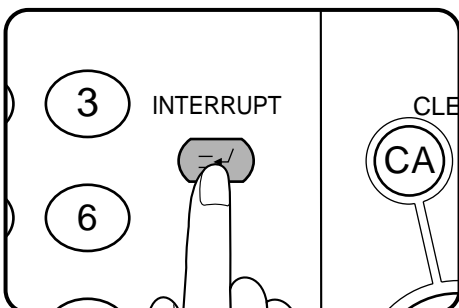

5 When the interrupt copy run is complete, press the INTERRUPT key again to cancel the mode and remove the original(s) used for interrupt copying.

- The copier will reset itself to the functions which were in use before the INTERRUPT key was first pressed.

6 Replace the original(s) for the interrupted job and press the START key to resume copying.

- If scanning of originals has been already complete, the original need not be replaced.

CHAPTER 3

SPECIAL FUNCTIONS

This chapter describes the special copying functions including various image editing functions which have been made possible by digital image processing technology.

	Page
• XY ZOOM	3-2
• MARGIN SHIFT	3-4
• ERASE	3-6
• DUAL PAGE COPYING	3-8
• MULTI SHOT	3-10
• COVERS	3-13
• TRANSPARENCY FILM WITH INSERT SHEETS	3-15
• PAMPHLET COPY	3-17
• IMAGE EDITING FUNCTIONS	3-20
Job build	3-20
Centering	3-22
Repeat copy	3-24
B/W reverse	3-27
Binding change	3-29
• TEXT STAMP	3-32
Date	3-32
Select stamp	3-35
Watermark	3-38
Page number	3-41
• TANDEM COPY	3-44
• SETTING REVIEW	3-46

XY ZOOM

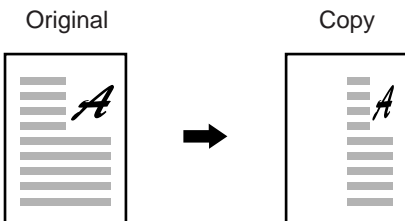

The XY ZOOM feature allows the horizontal and vertical copy ratios to be changed independently. If this feature is selected, the copy ratios can be set from 25% to 400%. (for the AR-407) or from 25% to 800% (for the AR-287 and AR-337). The illustrations below describe the case of the AR-407.

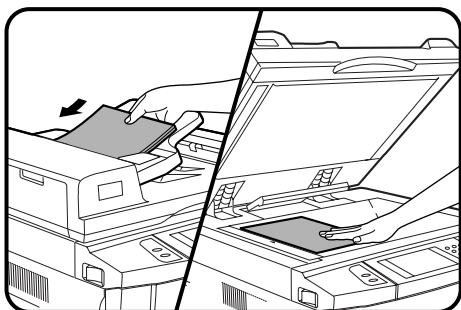

1 Place the original in the document feeder tray or on the document glass.

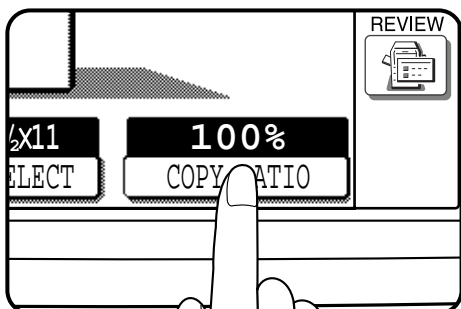

2 Press the “COPY RATIO” key on the touch panel.

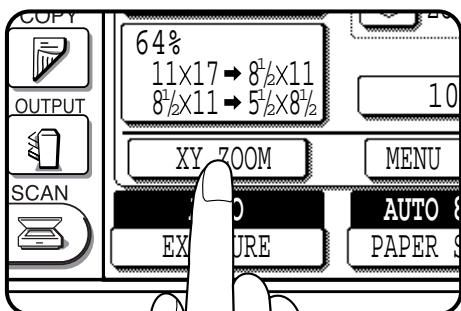

3 Press the “XY ZOOM” key.
 • The following screen will appear.

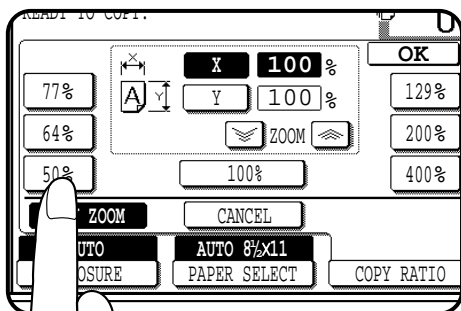
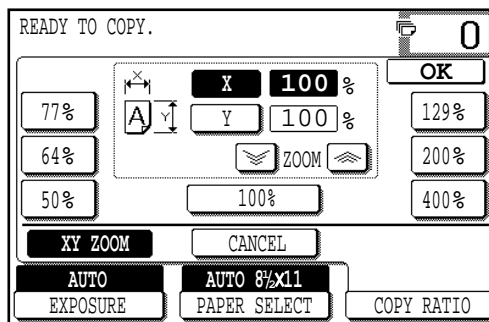

4 Use the reduction, enlargement, and ZOOM (☑, ☒) keys to change the copy ratio in the horizontal (X) direction.

- Press a reduction key or an enlargement key to set the approximate ratio, then press the ☑ key to decrease the ratio or ☒ key to increase the ratio.

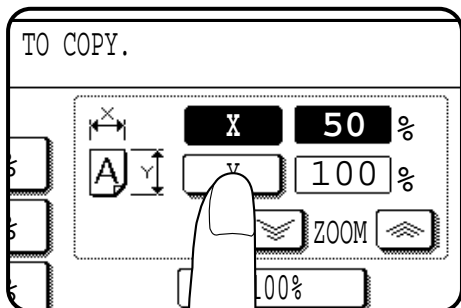

5 Press the **Y** key.

- The copy ratio in the vertical (Y) direction will be highlighted.

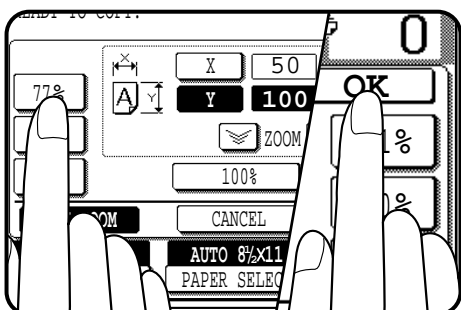

6 Use the reduction, enlargement, and **ZOOM** (⏪, ⏩) keys to change the copy ratio in the vertical (Y) direction.

- To change the copy ratio in the horizontal direction again, press the **X** key.
- The message “**IMAGE IS LARGER THAN THE COPY PAPER.**” may appear, indicating that the selected copy ratio is too large for the copy paper size. However, if you press the **START** key, a copy will be made.

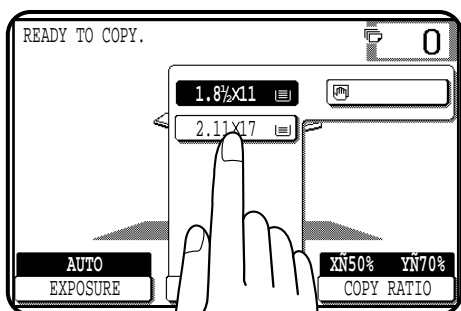

7 Press the “**OK**” key.

8 Press the “**PAPER SELECT**” key and select the paper tray with the desired paper size.

- If the **AUTO PAPER SELECT** mode is on, the appropriate copy paper size will have been automatically selected based on the original size and selected copy ratios.

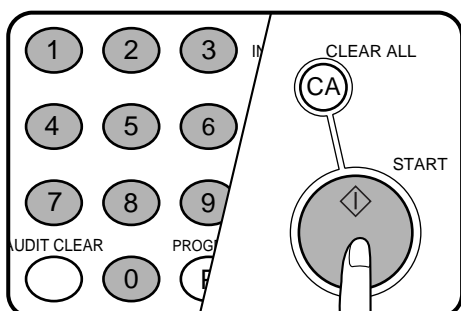

9 Enter the desired number of copies.

10 Press the **START** key.

- If the document feeder is used, scanning of originals and copying will start.
- If the document glass is used in the **SORT** mode, proceed to the next step.

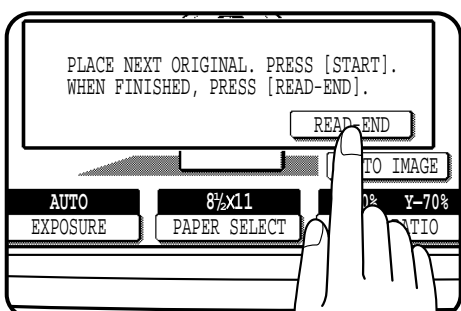

11 Replace the finished original with the next original after the **START** key indicator lights up, and then press the **START** key. Repeat this step until all originals have been scanned. Then, press the “**READ-END**” key on the touch panel.

- Copying will start at this time.
- Up to 120 sheets of 8-1/2" x 11" originals or up to 60 sheets of originals larger than 8-1/2" x 11" can be scanned.
- To cancel this function, press the “**CANCEL**” key or the “**XY ZOOM**” key again as in step 3.

MARGIN SHIFT

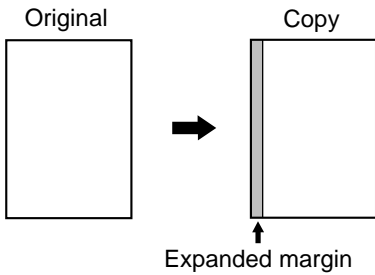

(Initial setting:
copy image shifted to the right)

The MARGIN SHIFT feature, in its initial setting, automatically shifts the text or image to the right both on one-sided copies and on the front side of two-sided copies. The text or image is shifted to the left on the reverse side of two-sided copies. Shift direction can be changed to left, up or down in the manner described below in step 4.

- The standard shift amount is 1/2", but can be changed from 0" to 1" in 1/8" increments.

★ **KEY OPERATOR** The initial shift setting can be changed from 0" to 1" in 1/8" increments. See page 16 of the **KEY OPERATOR'S GUIDE**.

NOTE:

The front side and reverse side are referred to as "SIDE 1" and "SIDE 2" respectively on the touch panel.

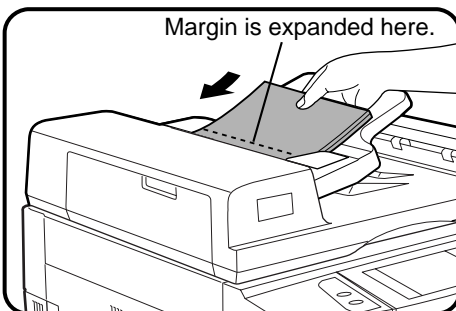

1 Place the original in the document feeder tray or on the document glass.

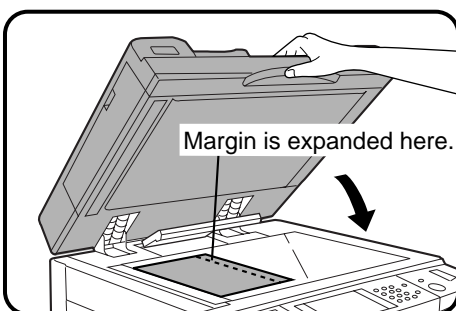

2 Press the **SPECIAL MODES** key.

- The SPECIAL MODES screen will appear.

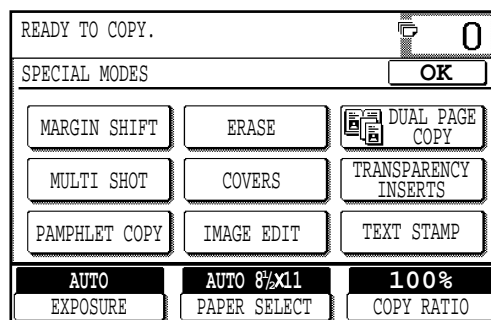
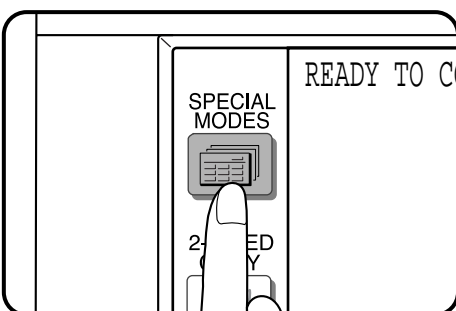

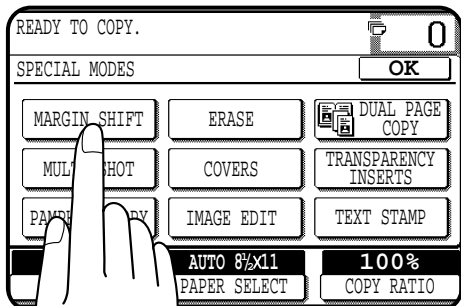

3 Press the “MARGIN SHIFT” key on the touch panel.

- The setting screen for MARGIN SHIFT will appear.

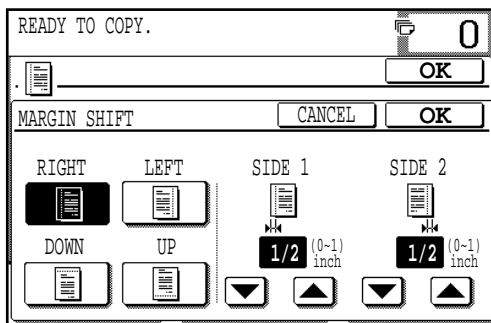

4 Select the shift direction.

- Select “RIGHT”, “LEFT”, “DOWN” or “UP” on the touch panel. The selected shift direction will be highlighted.

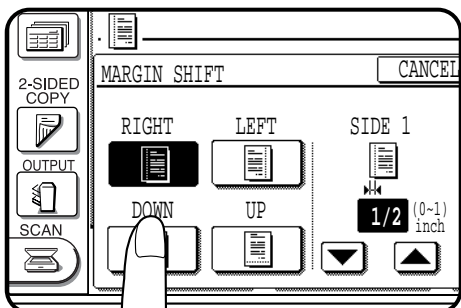

5 Select the desired shift amounts using the ▼ and ▲ keys.

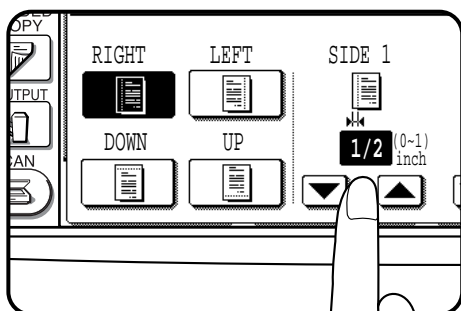

6 Press the upper “OK” key on the touch panel.

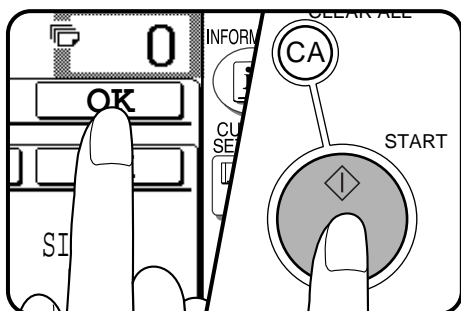

7 Make all other desired copier selections and press the START key.

- If the document feeder is used, scanning of originals and copying will start.
- If the document glass is used in the SORT mode, proceed to the next step.

8 Replace the finished original with the next original after the START key indicator lights up, and then press the START key. Repeat this step until all originals have been scanned. Then, press the “READ-END” key on the touch panel.

- Copying will start at this time.
- Up to 120 sheets of 8-1/2" x 11" originals or up to 60 sheets of originals larger than 8-1/2" x 11" can be scanned.
- To cancel the MARGIN SHIFT function, select the MARGIN SHIFT function again and press the “CANCEL” key.

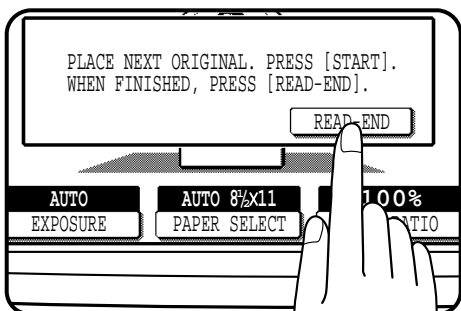

ERASE

Edge erase

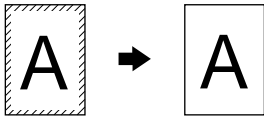

Center erase

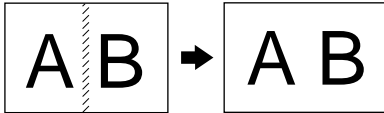

Edge + center erase

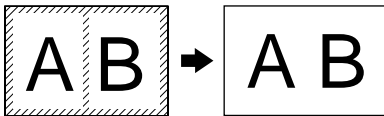

This copier has an edge erase mode and a center erase mode.

- Edge erase can be used to eliminate shadow lines around the edges of copies caused when thick paper or a book is used as an original.
- Center erase can be used to eliminate the shadow produced by the bindings of bound documents.
- Edge + center erase can be used to eliminate shadow lines around the edges of copies and to eliminate the shadow at the center of copies.
- The standard erase width is 1/2", but can be changed from 0" to 1" in 1/8" increments.

★ **KEY OPERATOR** The initial setting of the width for edge erase and center erase can be changed. See page 16 of the **KEY OPERATOR'S GUIDE**.

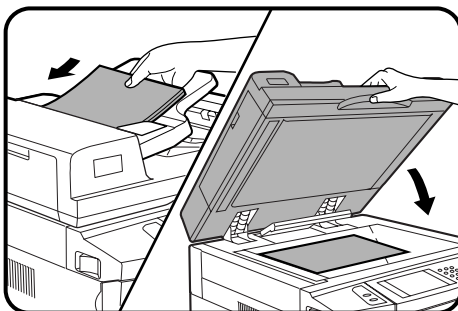

- 1 Place the original in the document feeder tray or on the document glass.

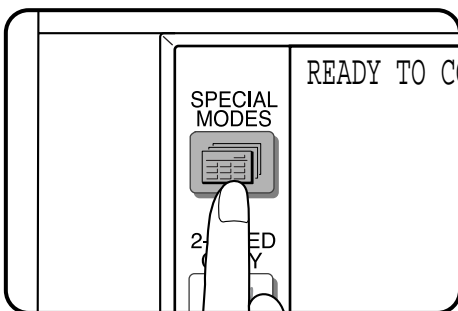

- 2 Press the **SPECIAL MODES** key.
 - The **SPECIAL MODES** screen will appear.

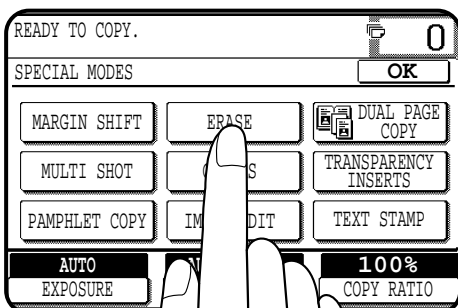

- 3 Press the **"ERASE"** key on the touch panel.
 - The setting screen for **ERASE** will appear.

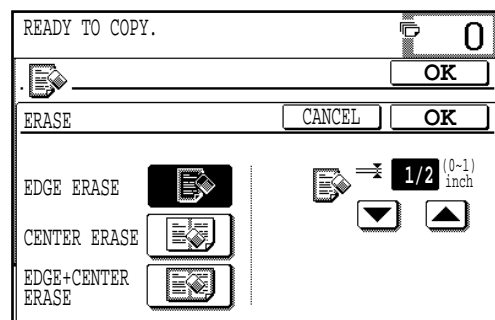

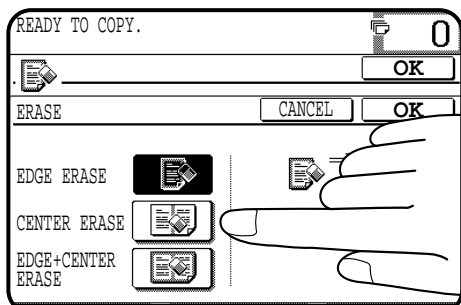

4 Select the desired erase mode.

- Select “EDGE ERASE”, “CENTER ERASE” or “EDGE+CENTER ERASE” on the touch panel. The selected erase mode will be highlighted.

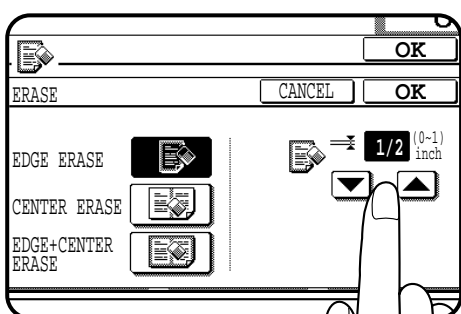

5 Adjust the amount of edge erase and/or center erase if needed.

- The amount can be adjusted between 0" and 1" in 1/8" increments.

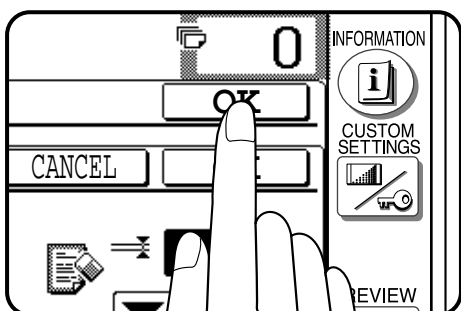

6 Press the upper “OK” key on the touch panel.

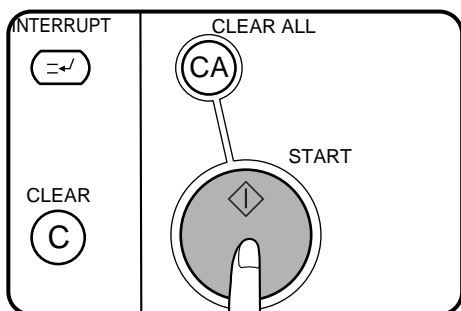

7 Make all other desired copier selections and press the START key.

- If the document feeder is used, scanning of originals and copying will start.
- If the document glass is used in the SORT mode, proceed to the next step.

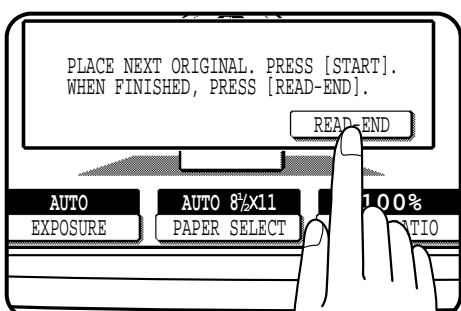

8 Replace the finished original with the next original after the START key indicator lights up, and then press the START key. Repeat this step until all originals have been scanned. Then, press the “READ-END” key on the touch panel.

- Copying will start at this time.
- Up to 120 sheets of 8-1/2" x 11" originals or up to 60 sheets of originals larger than 8-1/2" x 11" can be scanned.
- To cancel the ERASE function, select the ERASE function again and press the “CANCEL” key.

DUAL PAGE COPYING

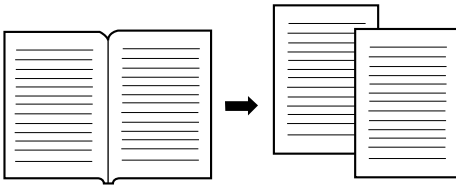

The DUAL PAGE COPY feature produces separate copies of two documents placed side by side on the document glass. It is especially useful when copying books and other bound documents. This feature can be used in the one-sided to two-sided copying mode.

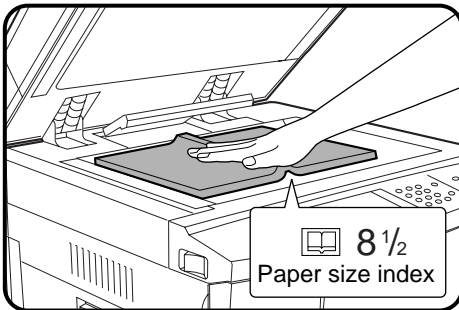

1 Place the originals on the document glass with the center of the two pages aligned with the paper size index $8\frac{1}{2}$. Close the document feeder cover.

- Set the page to be copied first on the left part of the document glass.

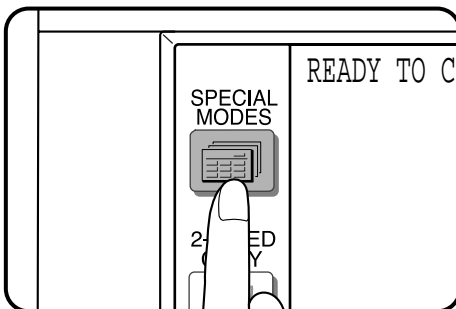

2 Press the SPECIAL MODES key.

- The SPECIAL MODES screen will appear.

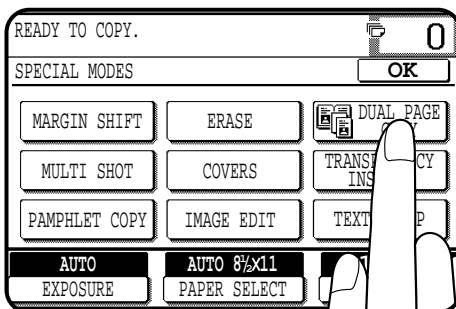

3 Press the “DUAL PAGE COPY” key on the touch panel.

- The “DUAL PAGE COPY” key will be highlighted.
- 8-1/2" x 11" sized copy paper will be automatically selected. If 8-1/2" x 11" copy paper is not loaded, copying can be performed with the currently selected tray.
- To leave a binding margin on the copy, select the MARGIN SHIFT function. See page 3-4. The MARGIN SHIFT feature applies only to the left page on the document glass if “RIGHT” or “LEFT” of MARGIN SHIFT has been selected.
- To erase shadows caused by document binding, use the EDGE ERASE feature. See page 3-6.

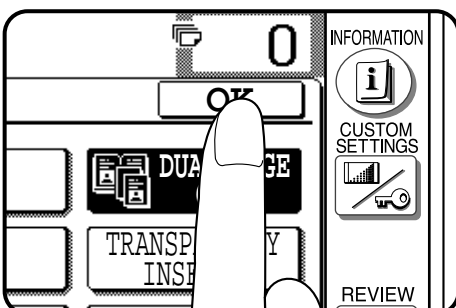

4 Press the “OK” key.

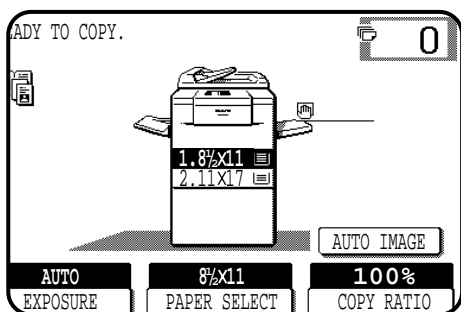

5 Ensure that the desired tray is selected.

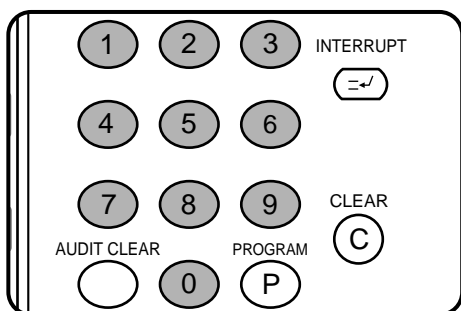

6 Enter the desired number of copies.

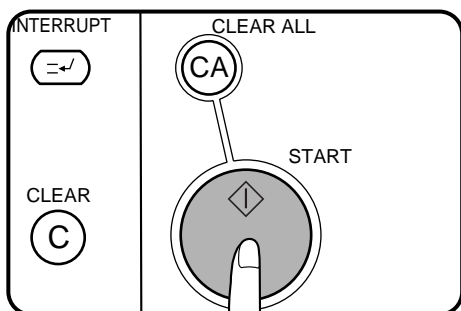

7 Press the **START** key.

- If the SORT mode has been selected for copying multiple originals, proceed to the next step. If not, copying will start.

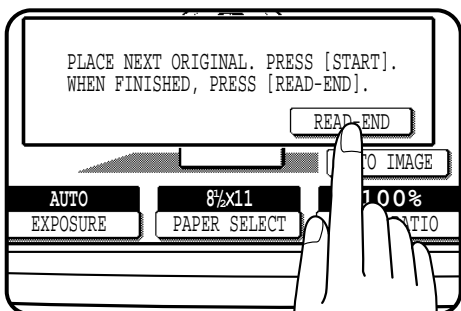

8 Replace the finished original with the next original after the **START** key indicator lights up, and then press the **START** key. Repeat this step until all originals have been scanned. Then, press the “**READ-END**” key on the touch panel.

- Copying will start at this time.
- Up to 60 sheets of 11" x 17" originals can be scanned.
- To cancel the DUAL PAGE COPY function, press the “DUAL PAGE COPY” key again on the SPECIAL MODES screen.

MULTI SHOT

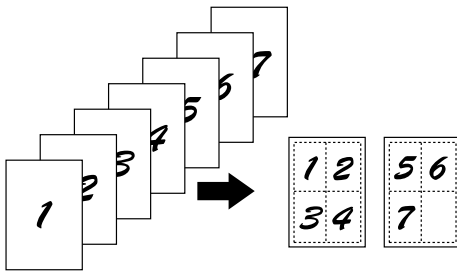

The MULTI SHOT function is used to copy several originals, collectively in a specified order, onto one sheet.

- When the MULTI SHOT is selected, the copy ratio is limited between 25% and 400%.

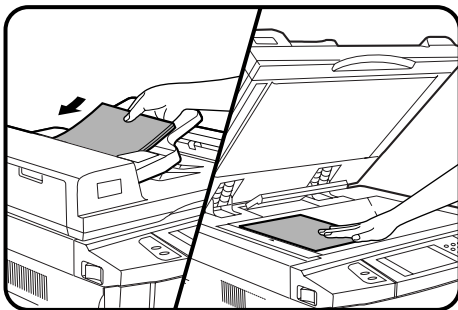

1 Place the originals in the document feeder tray or on the document glass.

- When using the document glass, place the originals one at a time in the reverse order, starting with the last original first.

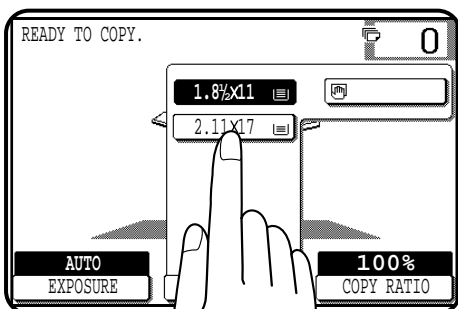

2 Press the “PAPER SELECT” key on the touch panel and select the desired paper size.

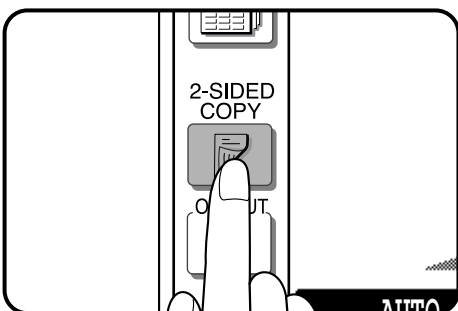

3 Press the 2-SIDED COPY key and select a duplex mode if desired. Press the “OK” key to close the duplex selection window.

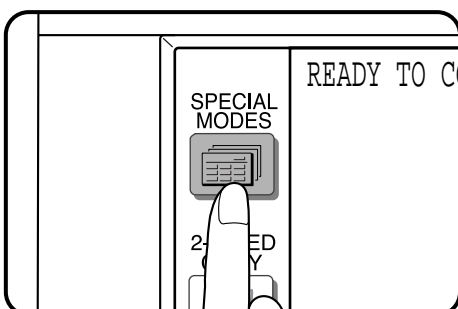

4 Press the SPECIAL MODES key.

- The SPECIAL MODES screen will appear.

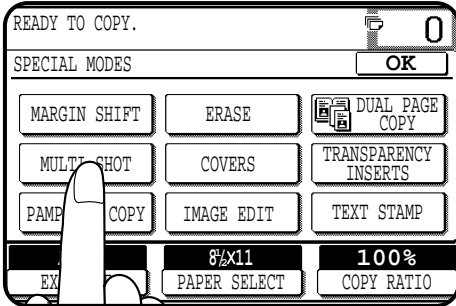

- 5** Press the “MULTI SHOT” key on the touch panel.
- The function setting screen for MULTI SHOT will appear.

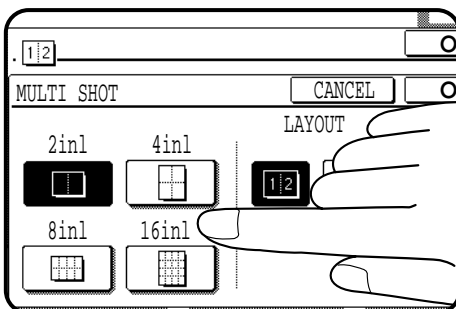
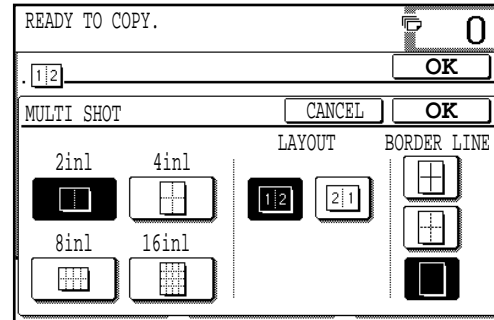

- 6** Select the number of originals to be included on one sheet of copies.

- Select “2in1”, “4in1”, “8in1” or “16in1” on the touch panel.
- The copy ratio will be calculated automatically.
- Portions of original images may not be copied depending on the original and copy paper sizes and the number of images to be copied onto a page.
- Depending on the number of originals and the orientation of the originals and copy paper, the image of the originals may be rotated.

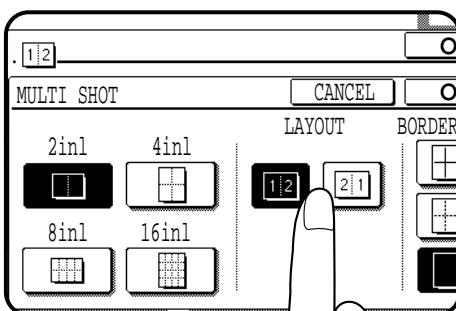

- 7** Select the layout of originals on the copy.

- Select the order of originals which will be arranged on the copy.
- For example, the following types are provided for “4in1”.

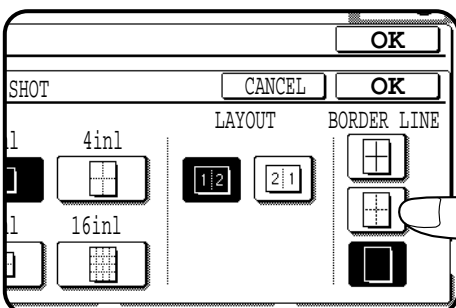
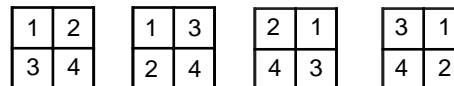

- 8** Select a type of border line.

- Select the solid line, broken line or no border line.

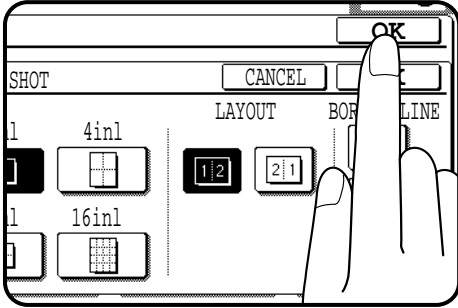

9 Press the upper “OK” key.

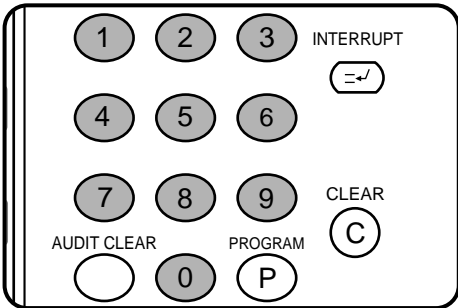

10 Enter the desired number of copies.

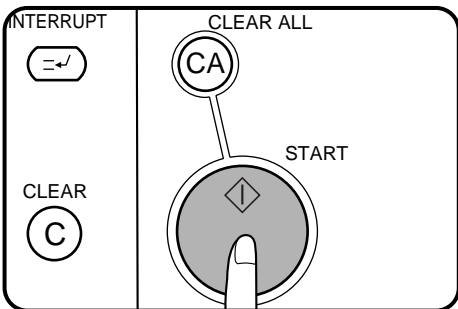

11 Press the **START** key.

- If the document feeder is used, copying will start after all originals are scanned.
- If the document glass is used, proceed to the next step.

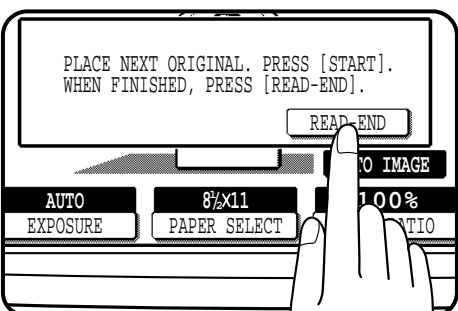

12 Replace the finished original with the next original after the **START** key indicator lights up, and then press the **START** key. Repeat this step until all originals have been scanned. Then, press the “READ-END” key on the touch panel.

- Copying will start at this time.
- Up to 120 sheets of 8-1/2" x 11" originals or up to 60 sheets of originals larger than 8-1/2" x 11" can be scanned.
- To cancel the MULTI SHOT function, select the MULTI SHOT function again and press the “CANCEL” key.

COVERS

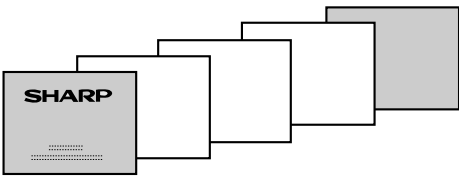

The COVERS mode is used to place covers on the front, back, or both the front and back of multipage documents.

- Front cover sheets can be copied on, but only on the front side even in the 1-sided to 2-sided and 2-sided to 2-sided copy modes. The back side of the original designated as the cover will not be copied.
- Back cover sheets cannot be copied on, either on the front side or on the back side.
- Cover sheets must be fed from the bypass tray and must be the same size as the copy paper being used to copy the document.
- When the COVERS mode is selected, the stream feeding mode of the RADF will always be off.

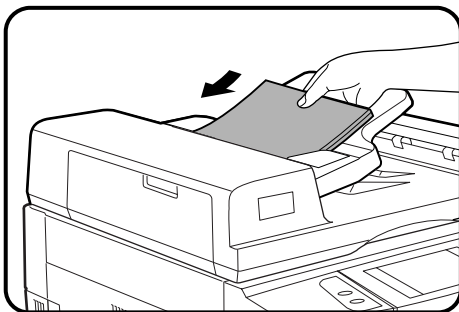

1 Place the originals in the document feeder tray.

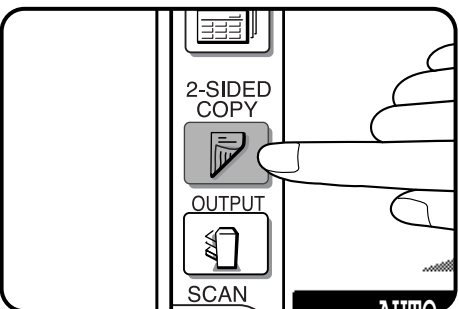

2 Press the 2-SIDED COPY key and select the desired duplex mode if needed. Press the “OK” key to close the duplex selection window.

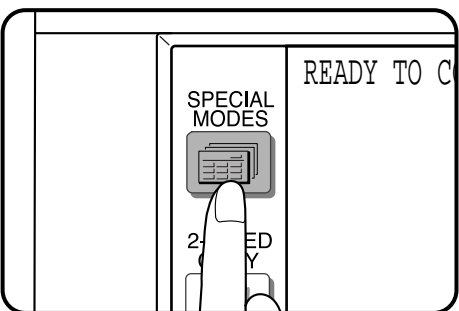

3 Press the SPECIAL MODES key.

- The SPECIAL MODES screen will appear.

4 Press the “COVERS” key on the touch panel.

- The setting screen for COVERS will appear.

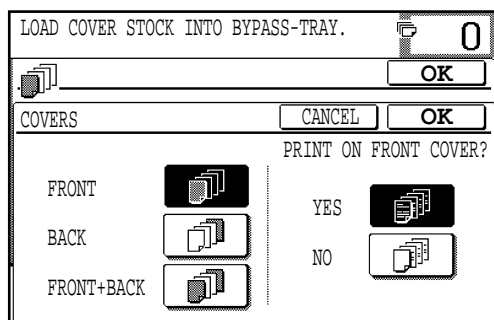
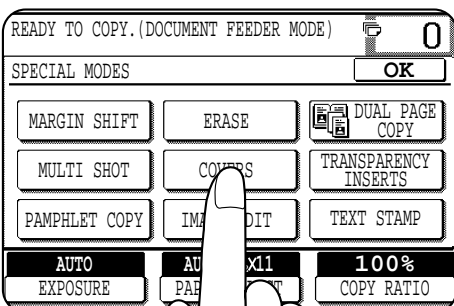

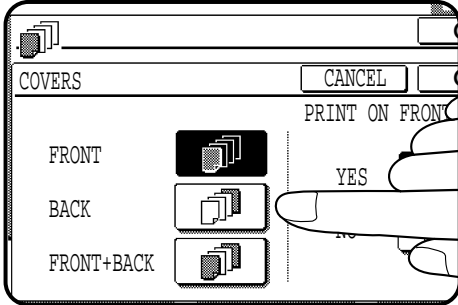

5 Select cover placement.

- Select “FRONT”, “BACK” or “FRONT+BACK” on the touch panel.

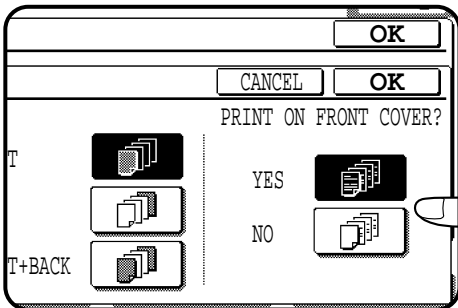

6 Indicate whether the front cover sheets are copied on or not.

- Select “YES” or “NO” on the touch panel. If “YES” is selected, the first page of the document will be copied onto the front cover sheet.
- If “BACK” has been selected in step 5, this selection is not needed.

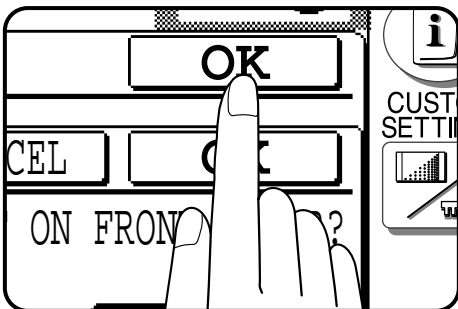

7 Press the upper “OK” key.

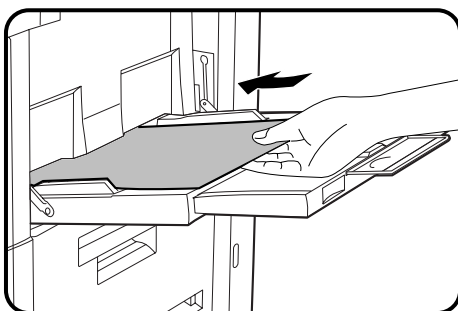

8 Load the cover stock into the bypass tray, making sure that the cover stock is the same size as the copy paper.

- The START key indicator will light up.

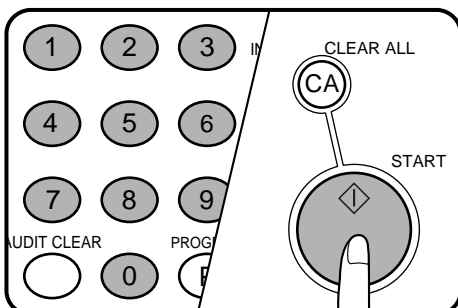

9 Enter the desired number of copies and press the START key.

- To cancel the COVERS function, select the COVERS function again and press the “CANCEL” key.

TRANSPARENCY FILM WITH INSERT SHEETS

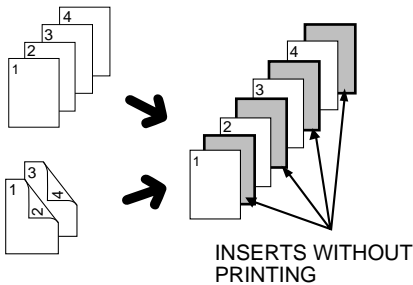
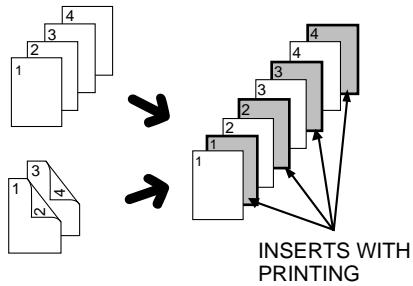

When copying onto transparency film, insert sheets can be placed following each transparent sheet. The insert sheets can be processed blank or can be copied with the same image as the transparent sheets.

- This mode can be selected only in the 1-sided to 1-sided and 2-sided to 1-sided modes.
- A multiple number of copies cannot be selected in this mode.
- Transparency film must be fed from the bypass tray.
- Insert sheets must be the same size as the transparency film.

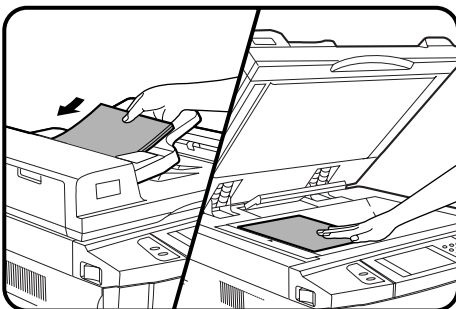

1 Place the originals in the document feeder tray or on the document glass.

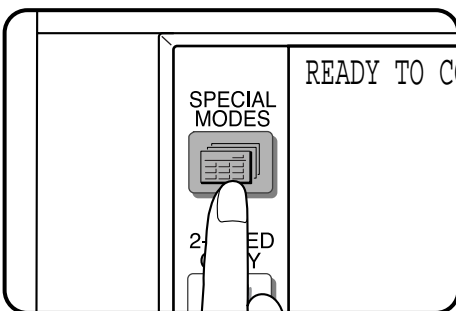

2 Press the **SPECIAL MODES** key.

- The SPECIAL MODES screen will appear.

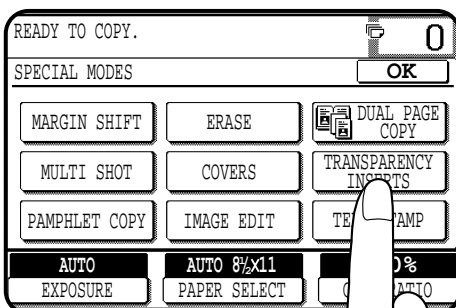

3 Press the “**TRANSPARENCY INSERTS**” key on the touch panel.

- The setting screen for TRANSPARENCY INSERTS will appear.

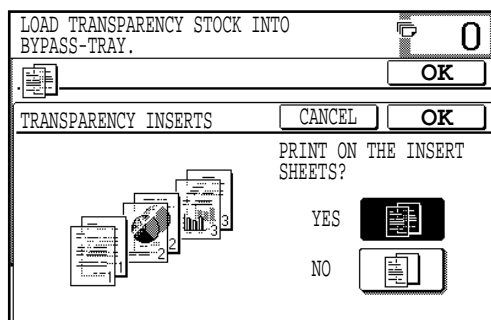

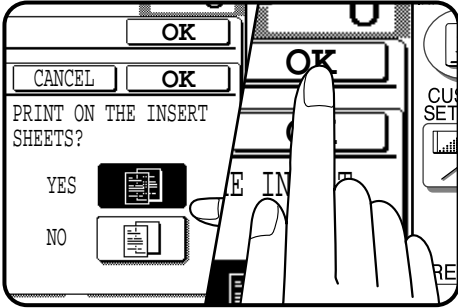

4 Indicate whether the insert sheets are copied on or not.

- Select “YES” or “NO” on the touch panel.

5 Press the upper “OK” key.

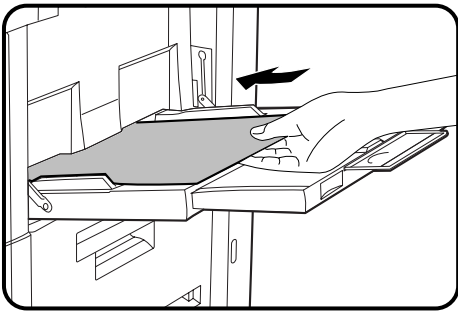

6 Load transparency film into the bypass tray.

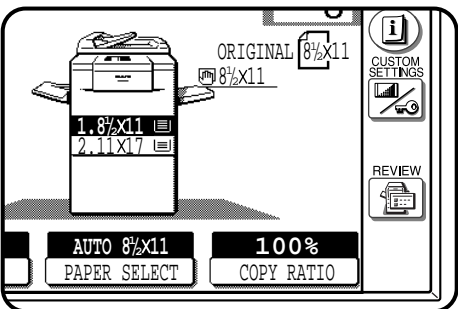

7 Ensure that the desired tray is selected for insert sheets.

- The copy paper for insert sheets must be the same size as the transparency film.

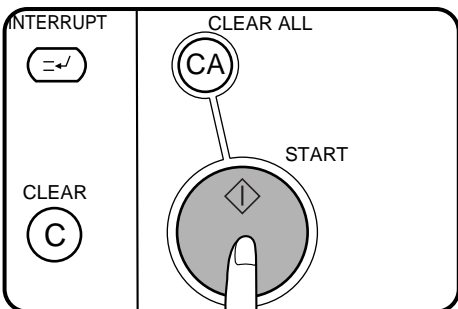

8 Make all other selections and press the **START** key.

- If the document feeder is used, scanning of originals and copying will start.
- If the document glass is used in the SORT mode, proceed to the next step.

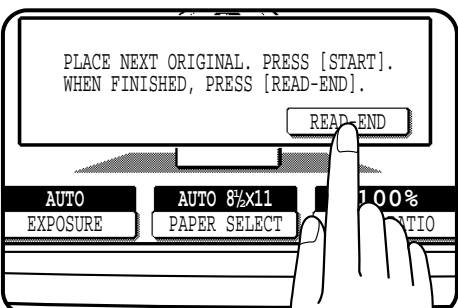

9 Replace the finished original with the next original after the **START** key indicator lights up, and then press the **START** key. Repeat this step until all originals have been scanned. Then, press the “**READ-END**” key on the touch panel.

- Copying will start at this time.
- Up to 120 sheets of 8-1/2" x 11" originals or up to 60 sheets of originals larger than 8-1/2" x 11" can be scanned.
- When copying is completed, remove remaining transparency film.
- To cancel the TRANSPARENCY INSERTS function, select the TRANSPARENCY INSERTS function again and press the “**CANCEL**” key.

PAMPHLET COPY

Originals
(1-sided)

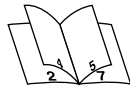
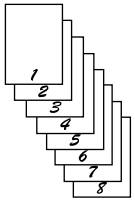

Originals
(2-sided)

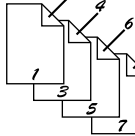

The PAMPHLET COPY function is used to arrange copies in proper order for eventual center-stapling and folding into a booklet. If the copy ratio is 100% and the auto paper select mode is on, the copy paper selected will be twice the size of the originals and will be copied on both sides. Four pages will be copied onto one sheet.

- Center stapling cannot be performed by this copier. Even if PAMPHLET COPY is selected and the optional finishers (AR-FN1N, AR-FN2) is installed, center-stapling cannot be performed.
- This function will not work when non-standard size originals or copy paper are used.
- When the PAMPHLET COPY function is selected, the copy ratio is limited between 25% and 400%.

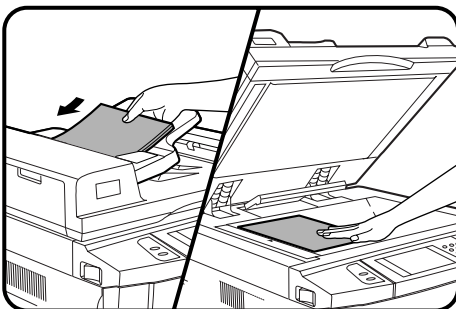

1 Place the originals in the document feeder tray or on the document glass.

- When using the document glass, place the originals one at a time in the reverse order, starting with the last original first.

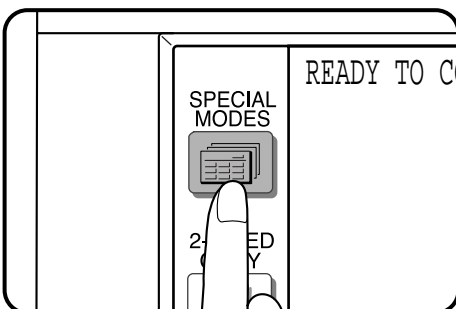

2 Press the SPECIAL MODES key.

- The SPECIAL MODES screen will appear.

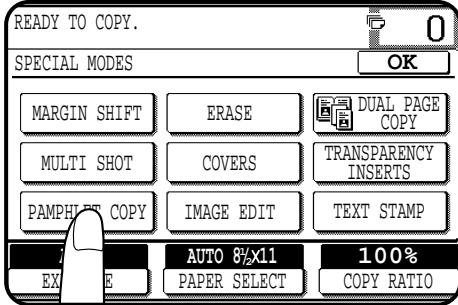

- 3 Press the “PAMPHLET COPY” key on the touch panel.**
- The setting screen for PAMPHLET COPY will appear.
 - Depending on installation of an optional component, the “PAMPHLET COPY” function may be included in the “IMAGE EDIT” menu. In this case, press the “IMAGE EDIT” key and then press the “PAMPHLET COPY” key.

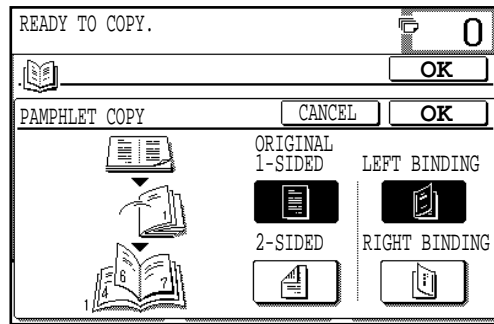

- 4 Select the type of originals.**
- Indicate whether the originals are 1-sided or 2-sided using the “1-SIDED” or “2-SIDED” key on the touch panel.

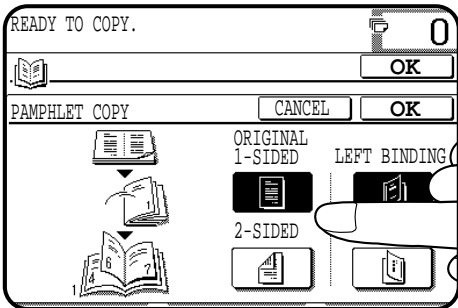

- 5 Select the binding position.**
- Select “LEFT BINDING” or “RIGHT BINDING” on the touch panel.

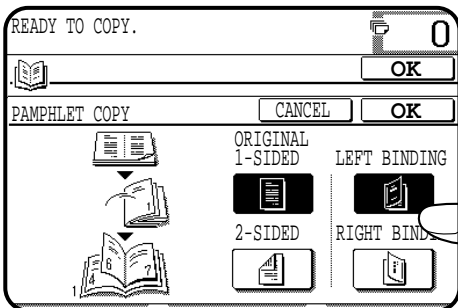

- 6 Press the upper “OK” key.**

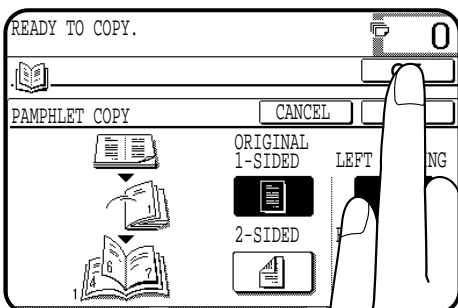

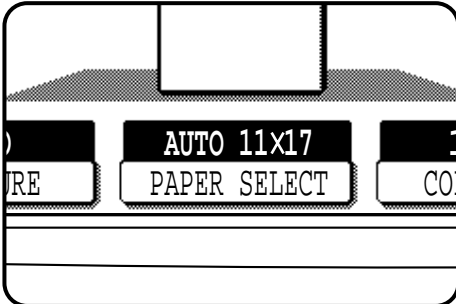

7 Check the copy paper selection.

- When the desired paper size is not selected, touch the desired paper tray on the touch panel then the AUTO IMAGE key. This lets the copier automatically set the best reduction or enlargement ratio and display it on the touch panel, judging from the placed original size and the desired paper size. (See steps 2 and 3 of page 2-11.)

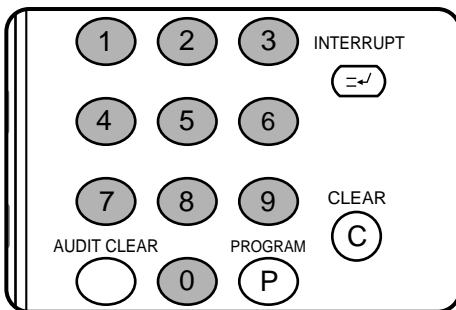

8 Enter the desired number of copies.

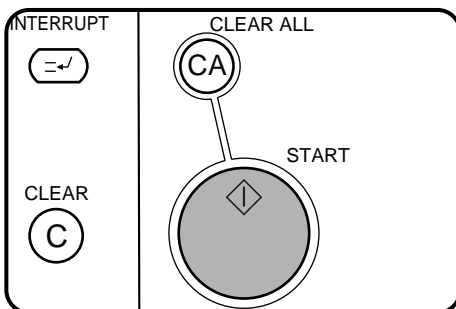

9 Press the START key.

- If the document feeder is used, copying will start after all originals are scanned.
- If the document glass is used, proceed to the next step.

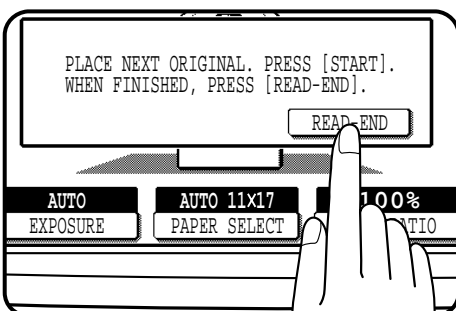

10 Replace the finished original with the next original after the START key indicator lights up, and then press the START key. Repeat this step until all originals have been scanned. Then, press the "READ-END" key on the touch panel.

- Copying will start at this time.
- Up to 120 sheets of 8-1/2" x 11" originals or up to 60 sheets of originals larger than 8-1/2" x 11" can be scanned.
- If originals of different sizes are used, the copy paper size will be determined based on the original that is scanned first. If originals larger than the first original are used, a portion of the images may not be copied.
- You can make a pamphlet by folding the copies in two and stapling them.
- To cancel the PAMPHLET COPY function, select the PAMPHLET COPY function again and press the "CANCEL" key.

IMAGE EDITING FUNCTIONS

The image editing functions include the following functions.

- Job build: Makes copies from a large volume of originals (up to 120 pages) using the document feeder.
- Centering: Shifts the image to the center of copy paper when the original and the copy paper are of different sizes.
- Repeat copy: Produces repeated copies on a single sheet of copy paper.
- B/W reverse: Reverses the black and white areas.
- Binding change: Rotates the image of originals for the second side in the 1-sided to 2-sided copy mode.

These functions are selected by pressing the "IMAGE EDIT" key on the SPECIAL MODES screen and pressing the key of each function.

CHAPTER 3

SPECIAL FUNCTIONS Image editing functions

JOB BUILD

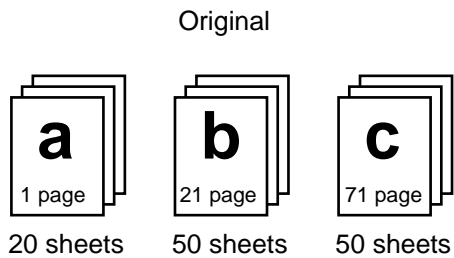

Divide the original containing more than 50 pages into some sections as shown above and feed them in the order of **c** → **b** → **a**. The original should be less than 120 pages in total. If the total page exceeds 120 (if the above section "a" exceeds 20 pages), the pages in excess of the limit will be output to the exit area without being copied.

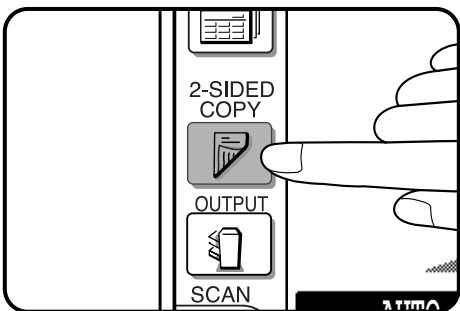
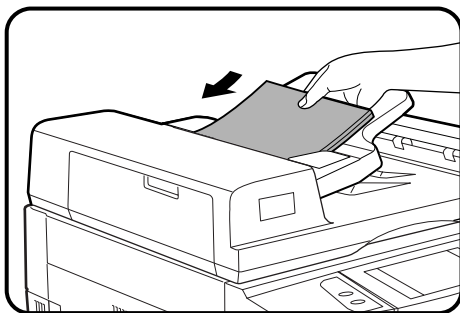

The JOB BUILD function allows copying of multipage documents containing up to 120 pages (the limit, however, might be up to 60 pages of 8-1/2" x 14" or 11" x 17" paper size when the copier is equipped with some option) using the RADF. The original must be divided into sections of up to 50 pages per section. Each section can be fed separately through the RADF for eventual copying into a complete set(s).

- Once a copy job is set in this mode, the copy mode can not be changed between the simplex and duplex modes except for INTERRUPT copying.
- When the JOB BUILD function is selected, the below mentioned functions can not be selected simultaneously. GROUP MODE/TRANSPARENCY INSERTS/DUAL PAGE COPY/REPEAT COPY.
- The JOB BUILD mode has priority over the stream feeding mode. Stream feeding will not operate while the JOB BUILD mode is selected.

The illustration shows an example when copying 120 pages of original.

1 Divide the multipage document (maximum 120 pages) into sections of 50 pages or less and place the section containing the first page of the document into the document feeder tray.

2 If a duplex copy mode is required, it must be selected at this time by pressing the 2-SIDED COPY key.

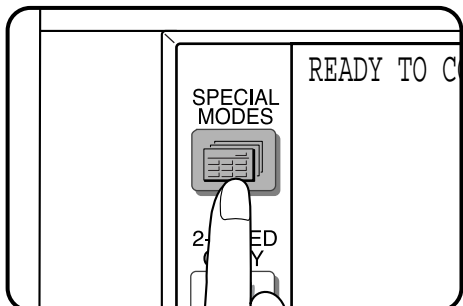

- 3** Press the **SPECIAL MODES** key.
- The SPECIAL MODES screen will appear.

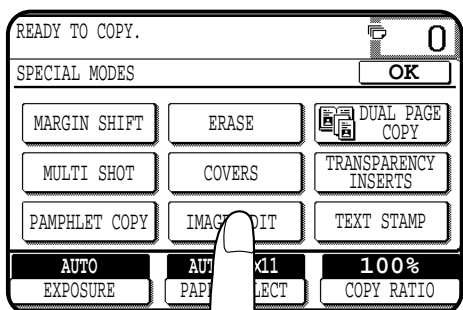

- 4** Press the **“IMAGE EDIT”** key.
- The IMAGE EDIT menu will appear.

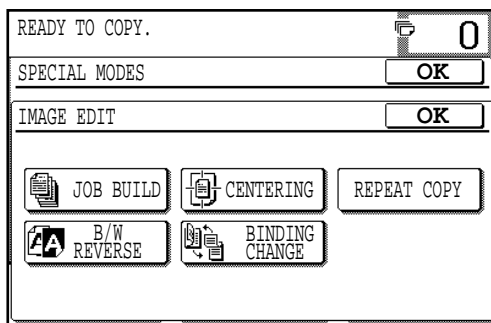

- 5** Press the **“JOB BUILD”** key.
- The **“JOB BUILD”** key will be highlighted.

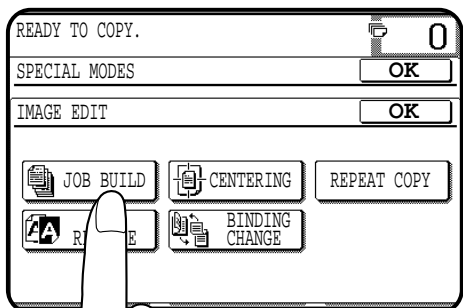

- 6** Press the upper **“OK”** key.

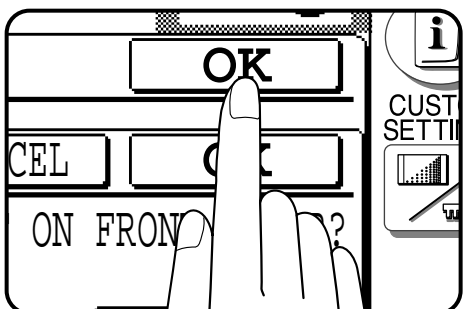

- 7** Make all other desired copy mode selections and enter the desired number of copies.

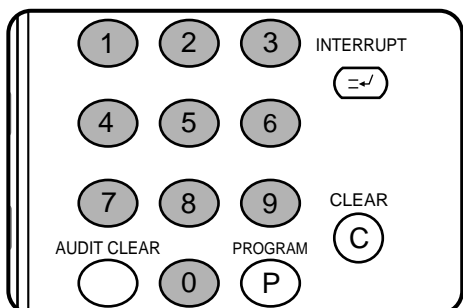

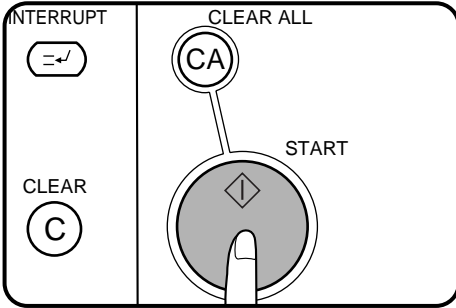

- 8** Press the **START** key.
- Scanning of the first section will start.

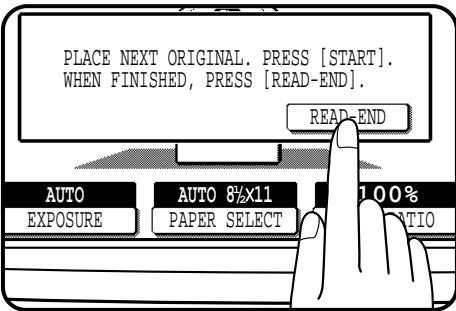

- 9** After the first section of original pages has been fed and the **START** lights up, remove the scanned originals from the exit area, set the next section of original pages into the document feeder tray and press the **START** key. Repeat this sequence until all sections have been fed. Then press the “**READ-END**” key on the touch panel.
- Copying will start at this time.

CENTERING

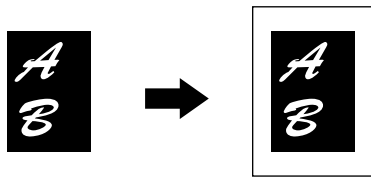

When the original and copy paper are of different sizes, **CENTERING** is used to shift the image as a whole to the center of the copy paper. The image will shift only in the left to right direction, not in the top to bottom direction.

- This function will not work when non-standard size originals or copy paper are used. This function cannot be selected when enlargement copying has been selected.

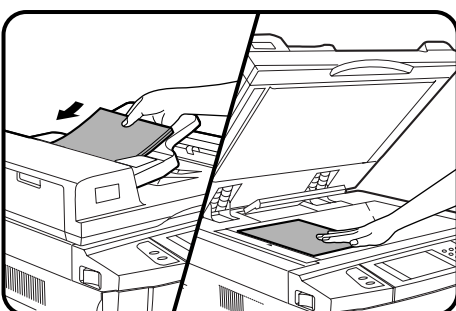

- 1** Place the originals in the document feeder tray or on the document glass.

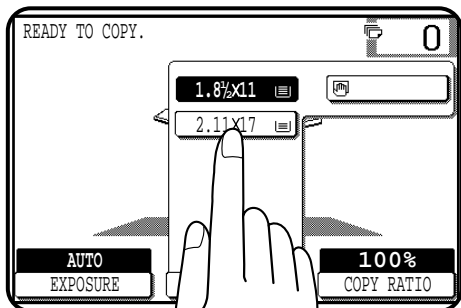

2 Press the “PAPER SELECT” key on the touch panel and select the desired paper size.

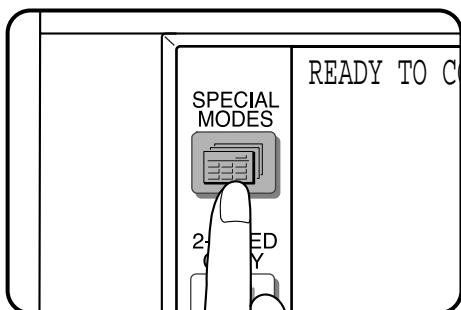

3 Press the SPECIAL MODES key.
 • The SPECIAL MODES screen will appear.

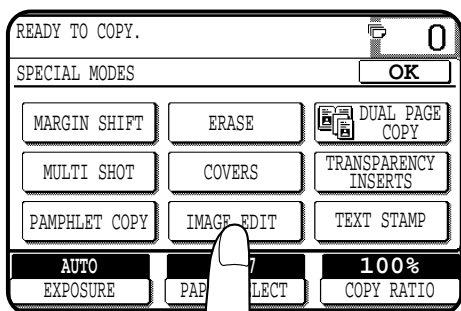

4 Press the “IMAGE EDIT” key on the touch panel.
 • The IMAGE EDIT menu will appear.

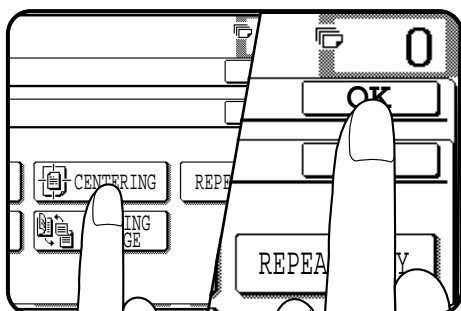

5 Press the “CENTERING” key.
 • The “CENTERING” key will be highlighted.

6 Press the upper “OK” key.

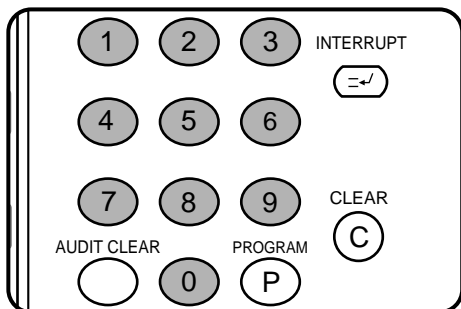

7 Make all other desired copier selections and enter the desired number of copies.

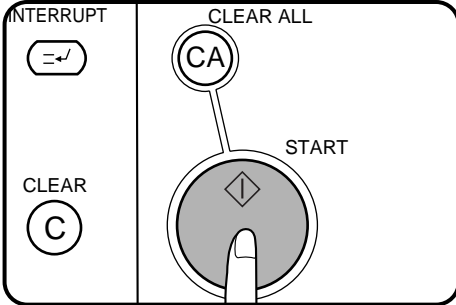

- 8 Press the START key.**
- If the document feeder is used, scanning of originals and copying will start.
 - If the document glass is used in the SORT mode, proceed to the next step.

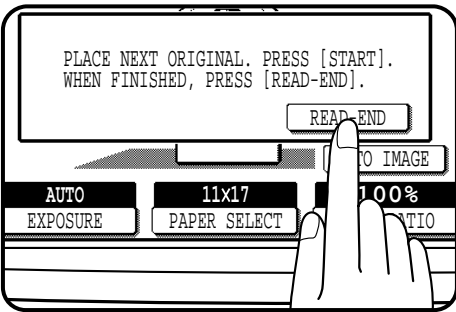

- 9 Replace the finished original with the next original after the START key indicator lights up, and then press the START key. Repeat this step until all originals have been scanned. Then, press the “READ-END” key on the touch panel.**
- Copying will start at this time.
 - Up to 120 sheets of 8-1/2" x 11" originals or up to 60 sheets of originals larger than 8-1/2" x 11" can be scanned.
 - To cancel the CENTERING function, press the “CENTERING” key again on the IMAGE EDIT menu screen.

REPEAT COPY

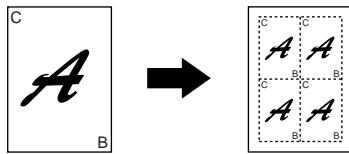

REPEAT COPY is used to produce repeated images of an original on a single sheet of paper. Border lines can be drawn to separate repeated images.

- Up to 16 (4 x 4) copies can be made on a single sheet.
- When a standard size original is copied onto a standard size paper, copy ratio will be automatically calculated based on the original size and the number of the images required in single sheet of paper. When the copier cannot detect the size of original, however, copy ratio will be automatically set to 100%.
- If the proper reduction ratio is calculated as less than 25%, part of the original will not be copied. In that case the reduction ratio will be set to 25% showing the following message on the display. “**IMAGE DOES NOT FIT INTO THE IMAGE AREA. COPY RATIO WILL BE SET TO 25%.**”

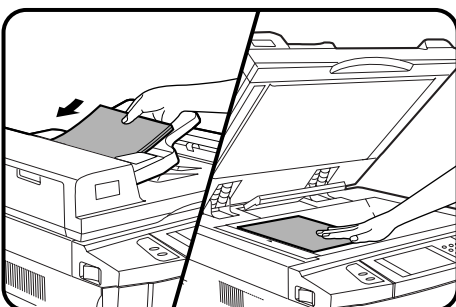

- 1 Place the originals in the document feeder tray or on the document glass.**

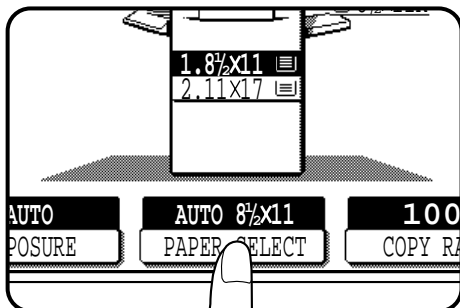

- 2** Select the desired copy paper size.
- Press the “PAPER SELECT” key on the touch panel and then select the desired paper size.

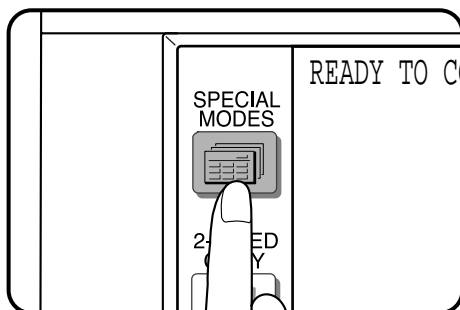

- 3** Press the SPECIAL MODES key.
- The SPECIAL MODES screen will appear.

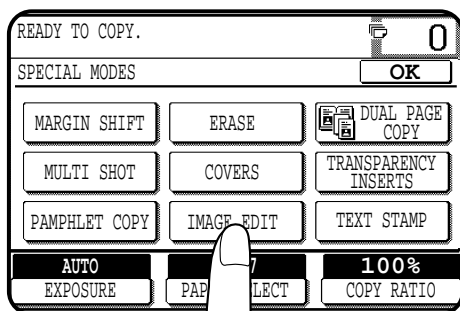

- 4** Press the “IMAGE EDIT” key on the touch panel.
- The IMAGE EDIT menu will appear.

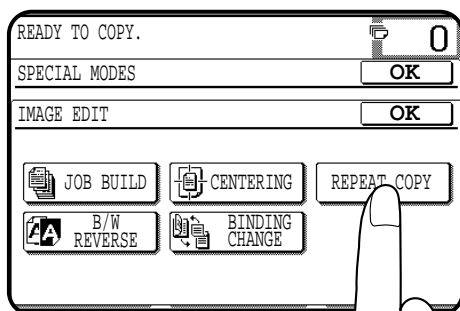

- 5** Press the “REPEAT COPY” key on the touch panel.
- The setting screen for REPEAT COPY will appear.

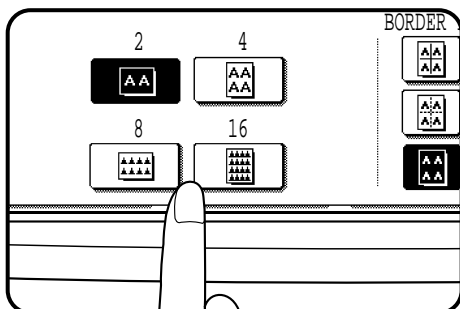
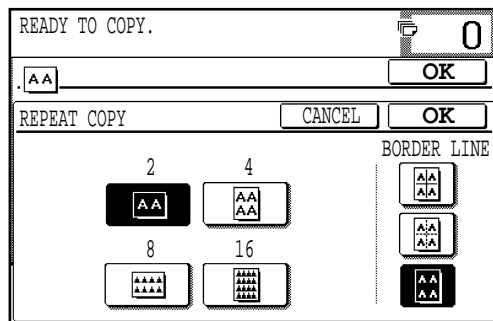

- 6** Select the number of images to be repeated on a single sheet of copy paper.
- Select “2”, “4”, “8” or “16” on the touch panel.

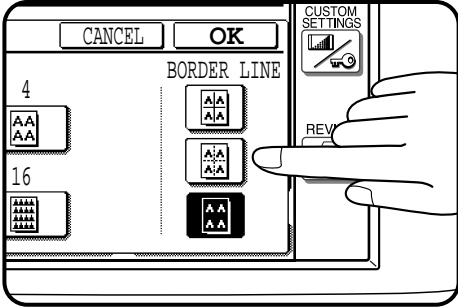

- 7** Select a type of border line.
- Select the solid line, broken line or no border line.

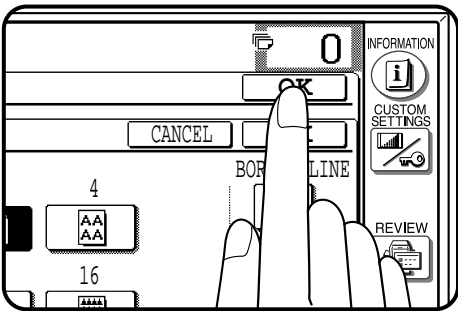

- 8** Press the upper "OK" key.

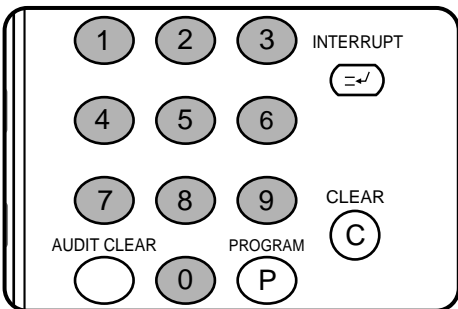

- 9** Make all other desired copier selections and enter the desired number of copies.
- If the required area of the originals is not included on the copies, select a proper reduction ratio.

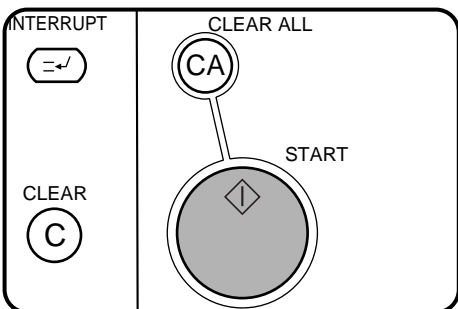

- 10** Press the START key.
- If the document feeder is used, scanning of originals and copying will start.
 - If the document glass is used in the SORT mode, proceed to the next step.

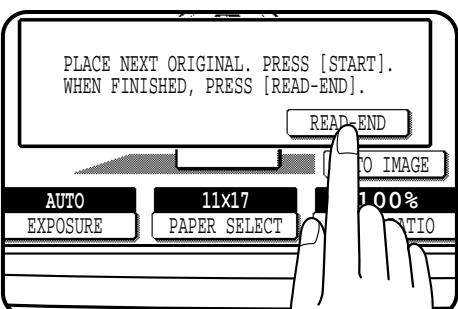

- 11** Replace the finished original with the next original after the START key indicator lights up, and then press the START key. Repeat this step until all originals have been scanned. Then, press the "READ-END" key on the touch panel.
- Copying will start at this time.
 - Up to 120 sheets of 8-1/2" x 11" originals or up to 60 sheets of originals larger than 8-1/2" x 11" can be scanned.
 - To cancel the REPEAT COPY function, select the REPEAT COPY function again and press the "CANCEL" key.

B/W REVERSE

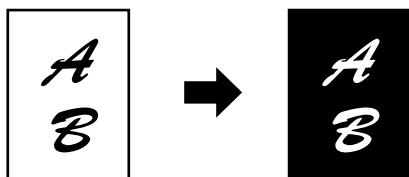

The B/W REVERSE feature is used to reverse black and white areas.

- When the B/W REVERSE feature is selected, the exposure mode will be automatically set to the TEXT mode. Other exposure modes cannot be selected. Even if this feature is canceled, the TEXT mode will not automatically be canceled.

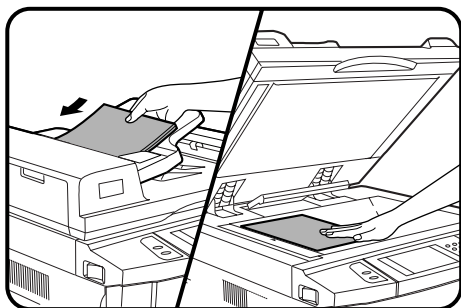

- 1 Place the original in the document feeder tray or on the document glass.**

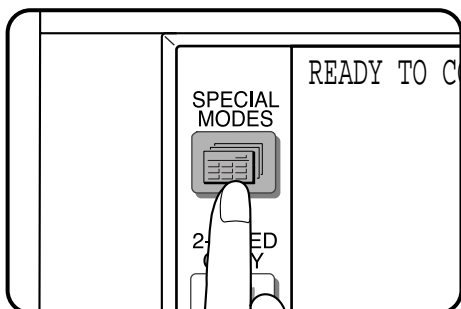

- 2 Press the SPECIAL MODES key.**
 - The SPECIAL MODES screen will appear.

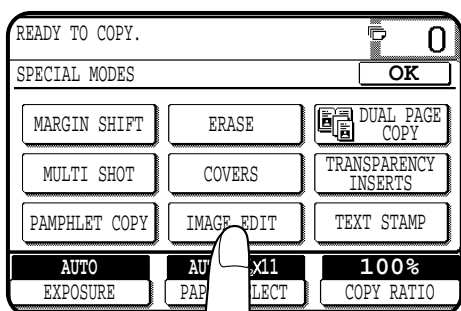

- 3 Press the "IMAGE EDIT" key on the touch panel.**
 - The IMAGE EDIT menu will appear.

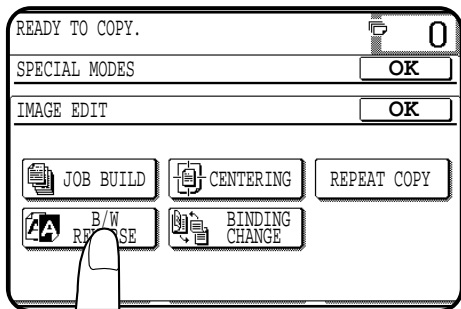

- 4 Press the "B/W REVERSE" key on the touch panel.**
 - The "B/W REVERSE" key will be highlighted.

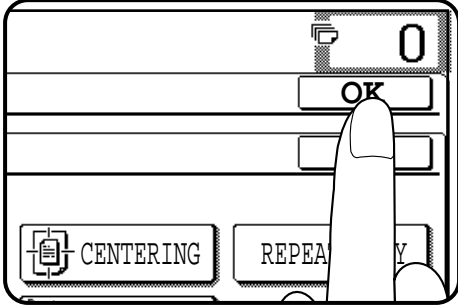

5 Press the upper “OK” key.

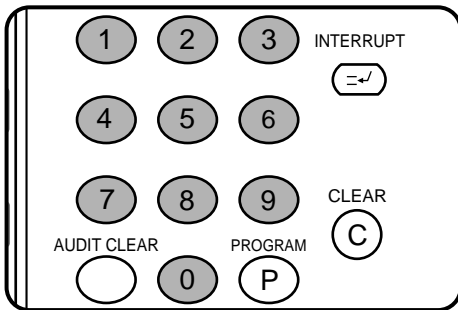

6 Make all other desired copier selections and enter the desired number of copies.

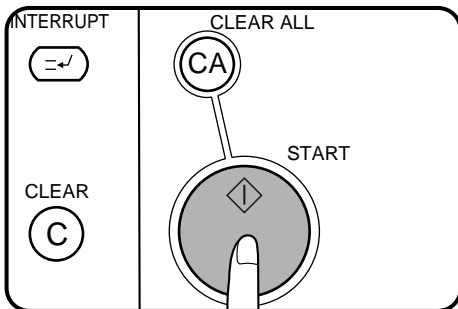

7 Press the **START** key.

- If the document feeder is used, scanning of originals and copying will start.
- If the document glass is used in the SORT mode, proceed to the next step.

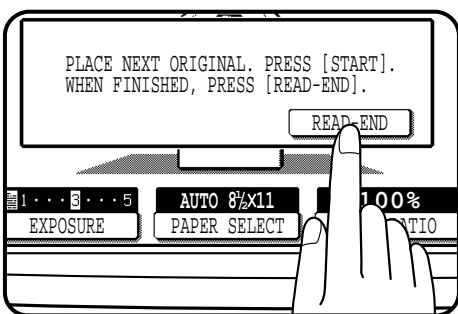





8 Replace the finished original with the next original after the **START** key indicator lights up, and then press the **START** key. Repeat this step until all originals have been scanned. Then, press the “READ-END” key on the touch panel.

- Copying will start at this time.
- Up to 120 sheets of 8-1/2" x 11" originals or up to 60 sheets of originals larger than 8-1/2" x 11" can be scanned.
- To cancel the B/W REVERSE function, press the “B/W REVERSE” key again on the IMAGE EDIT menu screen.

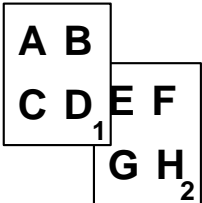
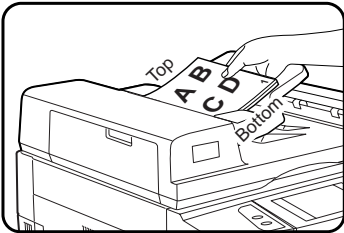
BINDING CHANGE

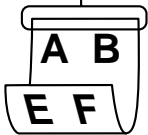
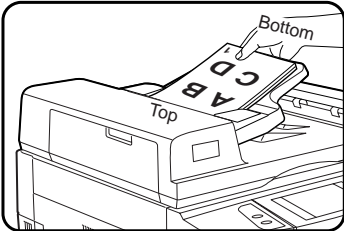
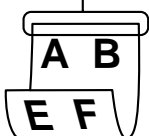
This function rotates the image of originals of the second side in the 1-sided to 2-sided copy mode. This function is useful for copying 8-1/2" x 14" or 11" x 17" originals in the 1-sided to 2-sided copy mode to allow left side binding.

Original	Setting of originals	Copies
	<p>Portrait orientation setting</p> 	<p>Normal 1-sided to 2-sided copying</p>  <p>The binding edge is at the left side.</p>
		<p>1-sided to 2-sided copying with binding change</p>  <p>The binding edge is at the top.</p>
	<p>Landscape orientation setting</p> 	<p>Normal 1-sided to 2-sided copying</p>  <p>The binding edge is at the top.</p>
		<p>1-sided to 2-sided copying with binding change</p>  <p>The binding edge is at the left side.</p>

- This function will not work when non-standard size paper or 5-1/2" x 8-1/2" paper is used.

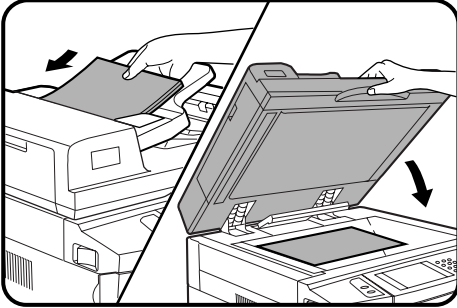

1 Place the originals in the document feeder tray or on the document glass.

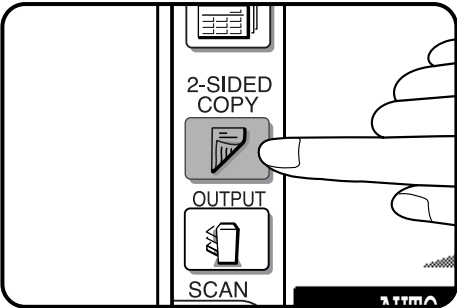

2 Press the 2-SIDED COPY key and select the 1-sided to 2-sided copy mode.

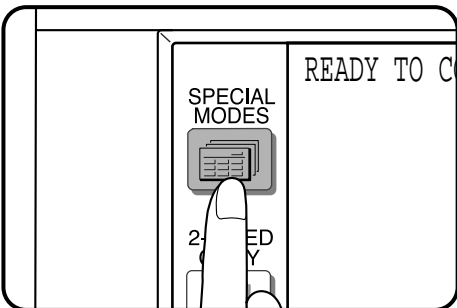

3 Press the SPECIAL MODES key.
 • The SPECIAL MODES screen will appear.

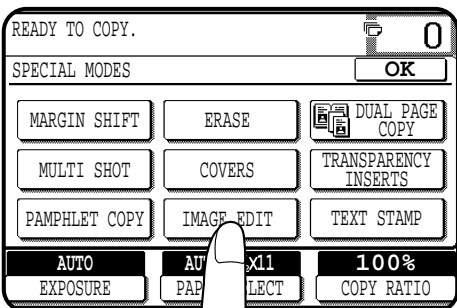

4 Press the “IMAGE EDIT” key on the touch panel.
 • The IMAGE EDIT menu will appear.

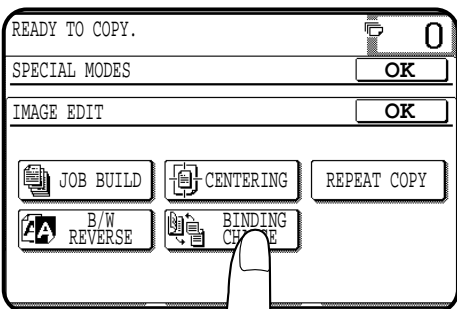

5 Press the “BINDING CHANGE” key on the touch panel.
 • The “BINDING CHANGE” key will be highlighted.

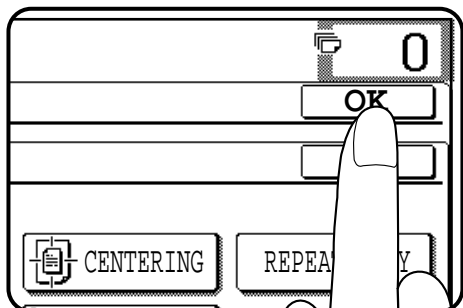

6 Press the upper “OK” key.

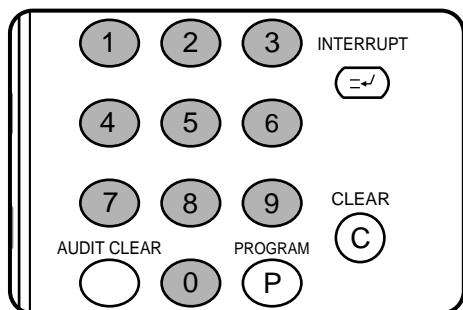

7 Make all other desired copier selections and enter the desired number of copies.

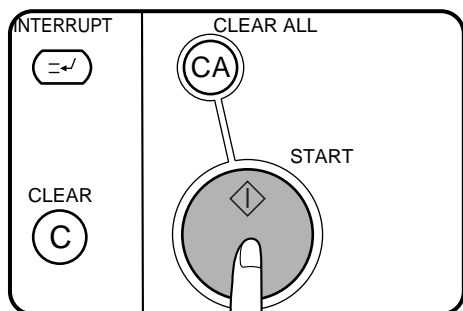

8 Press the **START** key.

- If the document feeder is used, scanning of originals and copying will start.
- If the document glass is used, proceed to the next step.

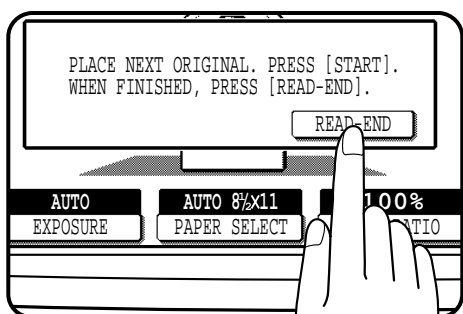

9 Replace the finished original with the next original after the **START** key indicator lights up, and then press the **START** key. Repeat this step until all originals have been scanned. Then, press the “READ-END” key on the touch panel.

- Copying will start at this time.
- Up to 120 sheets of 8-1/2" x 11" originals or up to 60 sheets of originals larger than 8-1/2" x 11" can be scanned.
- To cancel the **BINDING CHANGE** function, press the “**BINDING CHANGE**” key again on the **IMAGE EDIT** menu screen.

TEXT STAMP

The text stamp functions include the following functions.

- Date: Adds the current date to the copies.
- Select stamp: Adds a selected stamp to the copies. The stamp will be printed in white on a shaded background.
- Watermark: Adds a selected watermark to the copies. The watermark will be printed in gray tone.
- Page number: Adds page numbers to the copies.

These functions are selected by pressing the “TEXT STAMP” key on the SPECIAL MODES screen and then selecting from the “TEXT STAMP” menu.

- These functions will not work when non-standard size paper is used.
- Multiple text stamp functions can be selected at the same time except for SELECT STAMP and WATERMARK. These functions cannot be selected together.
- If the printed text stamp is located on the copy image, part of the copy image will be covered except for watermark. Part of watermark may be covered with the copy image.
- The size of printed characters is fixed. The size will not vary even in reduction or enlargement copying.

DATE

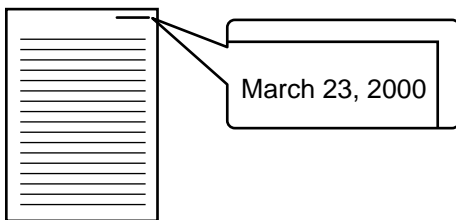

The DATE function adds the current date to the copies. The date will be printed at the upper right of the copies.

- If reduction or enlargement is used with this function, the print position may move or the date may not be printed.

★ **KEY OPERATOR** To use the DATE function, set the current date and time. See page 19 of the KEY OPERATOR'S GUIDE. The initial setting of the date format can be changed. See page 18 of the KEY OPERATOR'S GUIDE.

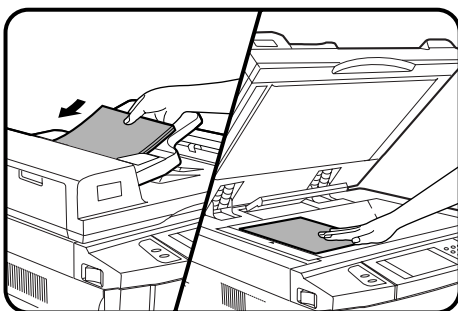

- 1 Place the originals in the document feeder tray or on the document glass.

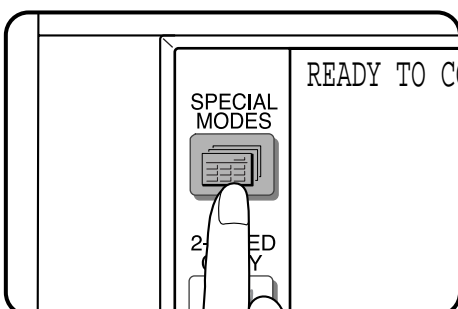

- 2 Press the SPECIAL MODES key.
 - The SPECIAL MODES screen will appear.

- 3** Press the “TEXT STAMP” key on the touch panel.
- The TEXT STAMP menu will appear.

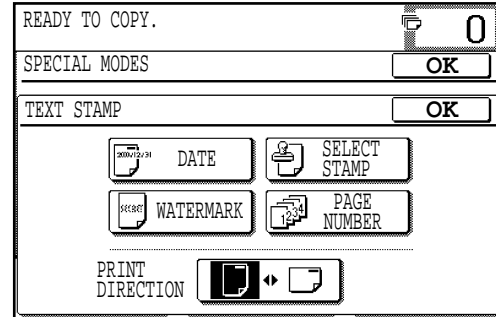
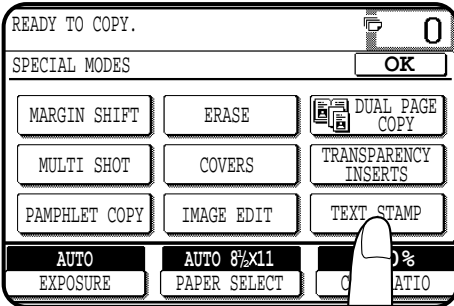

- 4** Press the “DATE” key on the touch panel.
- The setting screen for DATE will appear.

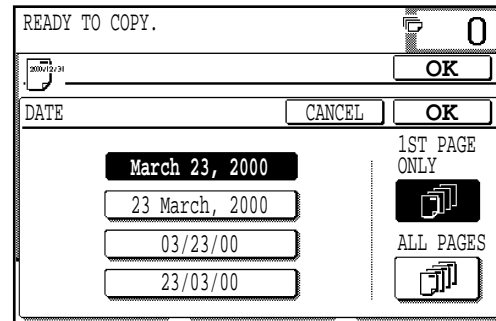
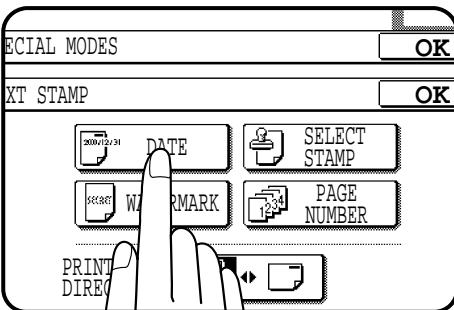

- 5** Select the desired date format on the touch panel.
- The selected format will be highlighted.

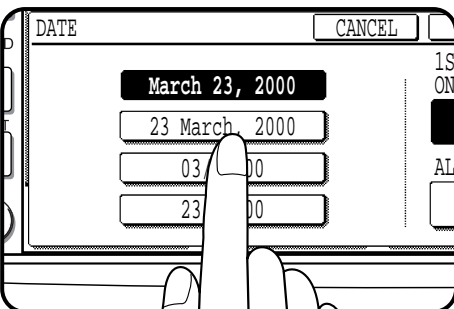

- 6** Select the pages to be stamped.
- Indicate whether the date is to be printed only on the first page or on all pages, by pressing the “1ST PAGE ONLY” or “ALL PAGES” key.

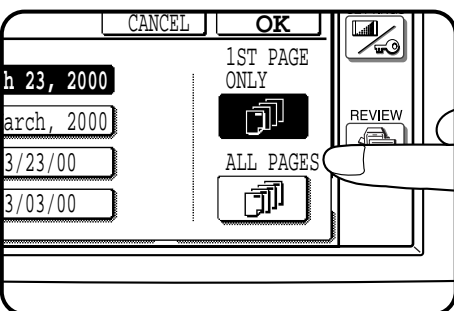

- 7** Press the lower “OK” key.
- The TEXT STAMP menu will appear again.

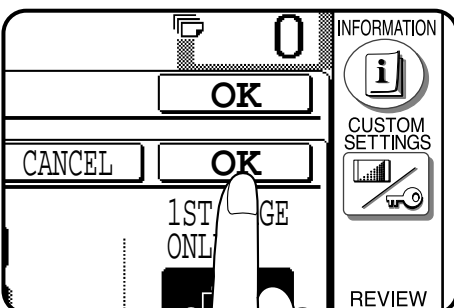

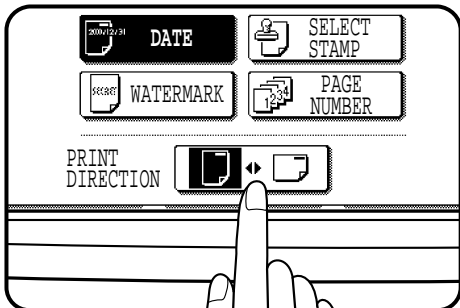

- 8** Select the print direction.
- If the PAMPHLET COPY function is used with this function, the portrait orientation (📄) must be selected.

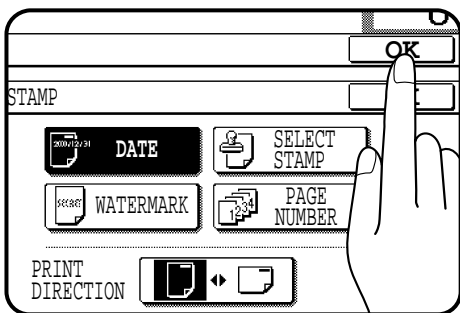

- 9** Press the upper “OK” key.

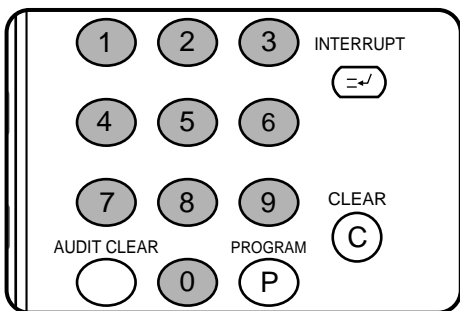

- 10** Make all other desired copier selections and enter the desired number of copies.

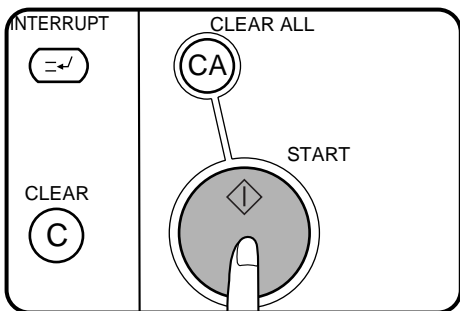

- 11** Press the START key.
- If the document feeder is used, scanning of originals and copying will start.
 - If the document glass is used, proceed to the next step.

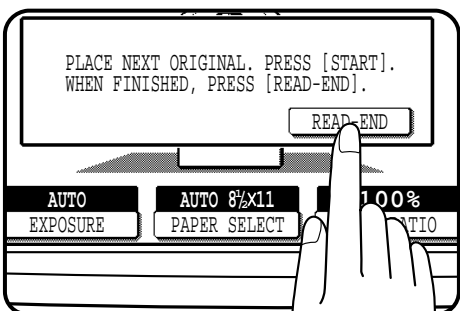

- 12** Replace the finished original with the next original after the START key indicator lights up, and then press the START key. Repeat this step until all originals have been scanned. Then, press the “READ-END” key on the touch panel.
- Copying will start at this time.
 - Up to 120 sheets of 8-1/2" x 11" originals or up to 60 sheets of originals larger than 8-1/2" x 11" can be scanned.
 - To cancel the DATE function, select the DATE function again and press the “CANCEL” key.

SELECT STAMP

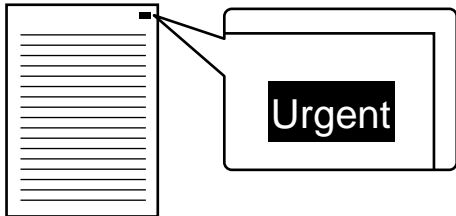

The SELECT STAMP function adds a selected stamp such as “Confidential” and “Urgent” to the copies. The stamp will be printed in white on a shaded background.

- The stamps which can be selected are: “Confidential”, “Urgent”, “Copy”, “Preliminary”, “Draft”, and “Final”.
- The darkness of the shaded background can be adjusted in three levels.
- The print position can be selected from six positions.
- If reduction or enlargement is used with this function, the print position may move or the stamp may not be printed.

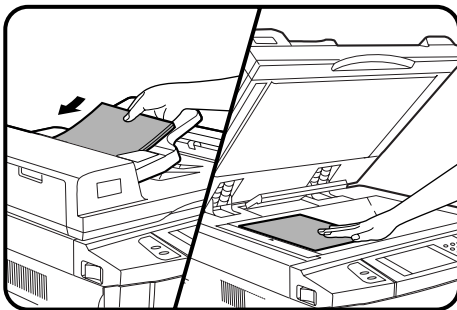

1 Place the originals in the document feeder tray or on the document glass.

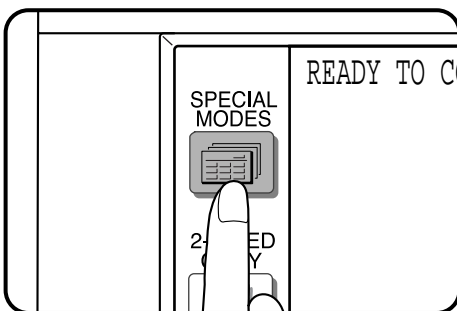

2 Press the SPECIAL MODES key.
• The SPECIAL MODES screen will appear.

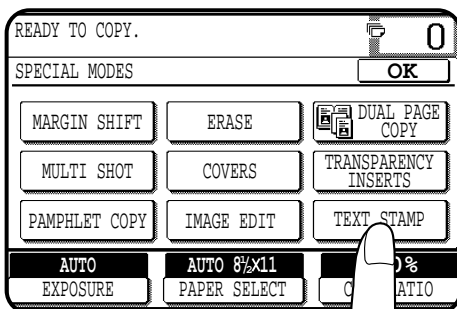

3 Press the “TEXT STAMP” key on the touch panel.
• The TEXT STAMP menu will appear.

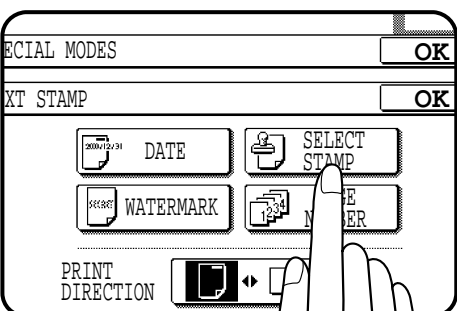

4 Press the “SELECT STAMP” key on the touch panel.
• The setting screen for SELECT STAMP will appear.

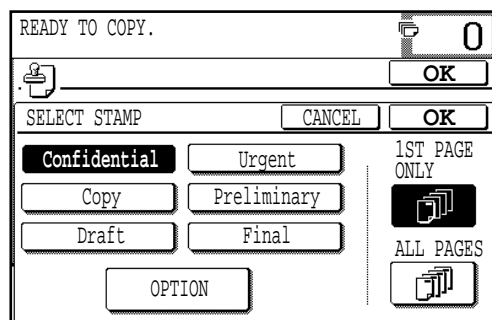

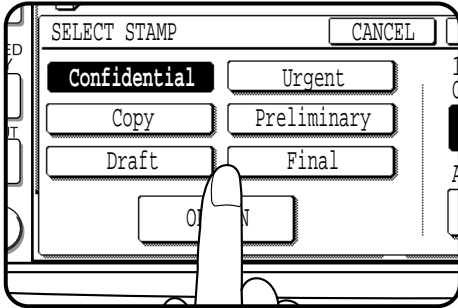

5 Select the desired stamp to be printed.

- The selected stamp will be highlighted.

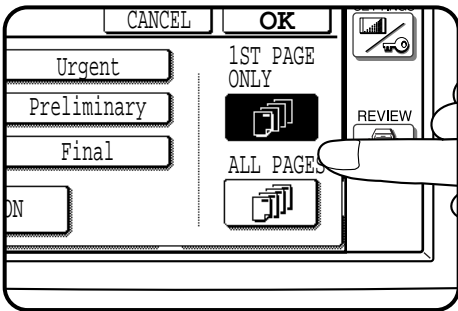

6 Select the pages to be stamped.

- Indicate whether the stamp is to be printed only on the first page or on all pages, by pressing the “1ST PAGE ONLY” or “ALL PAGES” key.

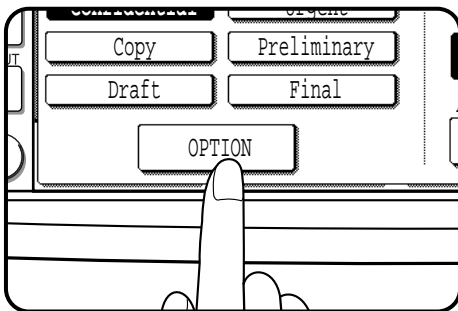

7 To adjust the exposure and print position, press the “OPTION” key. Otherwise, proceed to step 10.

- The following screen will appear.

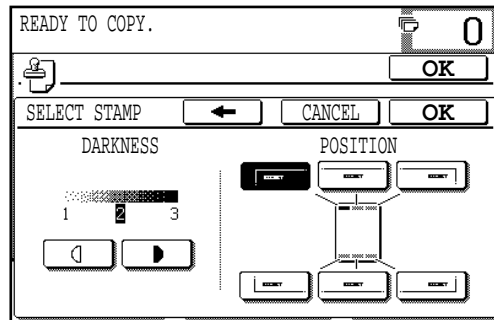

8 Adjust the darkness of the background of the stamp.

- Press the key to darken or the key to lighten.

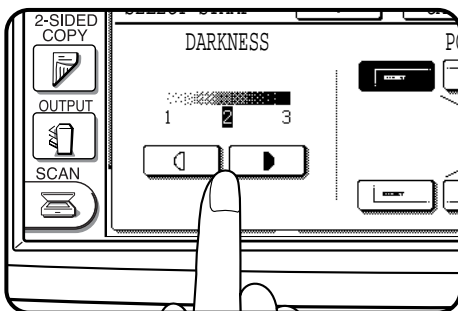

9 Select the stamp position.

- The selected position will be highlighted.
- To return to the previous screen, press the key.

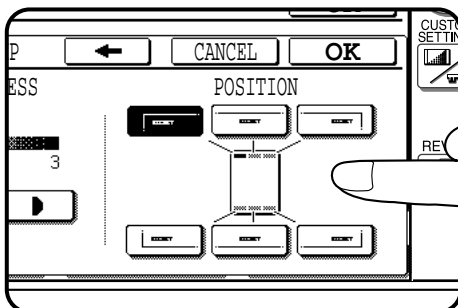

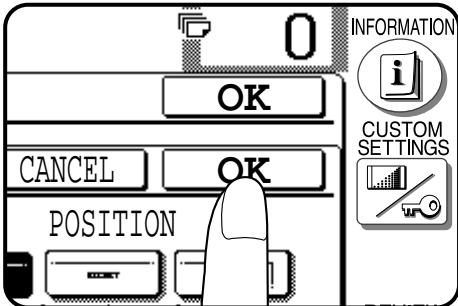

- 10** Press the lower “OK” key.
- The TEXT STAMP menu will appear again.

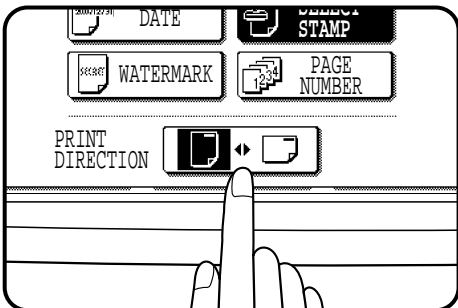

- 11** Select the print direction.
- If the PAMPHLET COPY function is used with this function, the portrait orientation (☐) must be selected.

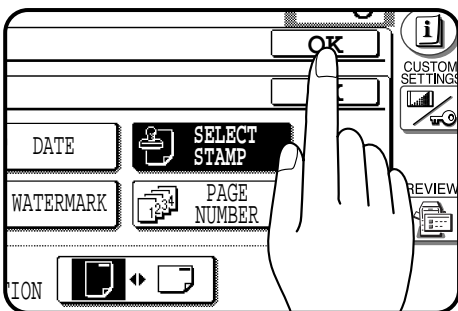

- 12** Press the upper “OK” key.

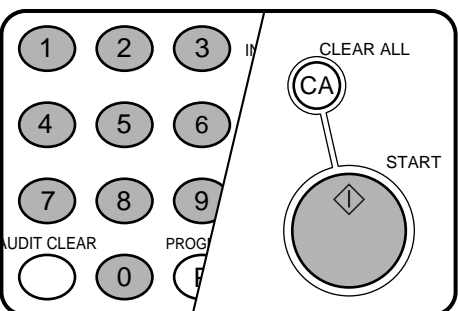

- 13** Make all other desired copier selections and enter the desired number of copies.

- 14** Press the START key.
- If the document feeder is used, scanning of originals and copying will start.
 - If the document glass is used, proceed to the next step.

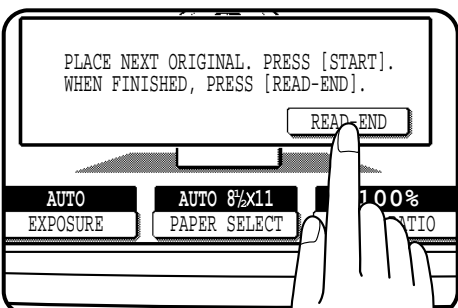

- 15** Replace the finished original with the next original after the START key indicator lights up, and then press the START key. Repeat this step until all originals have been scanned. Then, press the “READ-END” key on the touch panel.

- Copying will start at this time.
- Up to 120 sheets of 8-1/2" x 11" originals or up to 60 sheets of originals larger than 8-1/2" x 11" can be scanned.
- To cancel the SELECT STAMP function, select the SELECT STAMP function again and press the “CANCEL” key.

WATERMARK

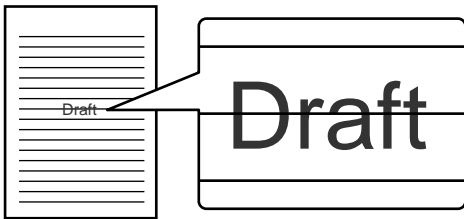

The WATERMARK function adds a selected watermark such as “Confidential” and “Urgent” to the copies. The watermark will be printed in gray tone at the center of copies.

- The watermarks which can be selected are: “Confidential”, “Urgent”, “Copy”, “Preliminary”, “Draft”, and “Final”.
- The darkness of the watermark can be adjusted in two levels.

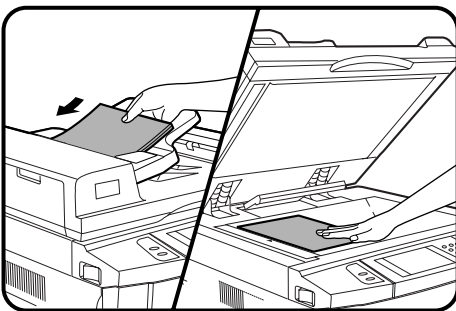

1 Place the originals in the document feeder tray or on the document glass.

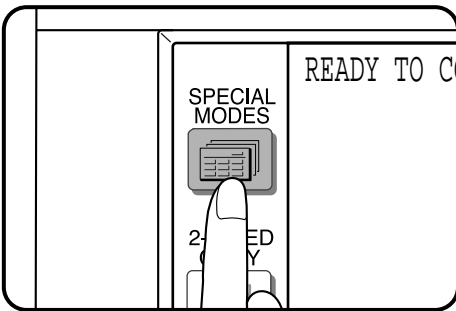

2 Press the SPECIAL MODES key.

- The SPECIAL MODES screen will appear.

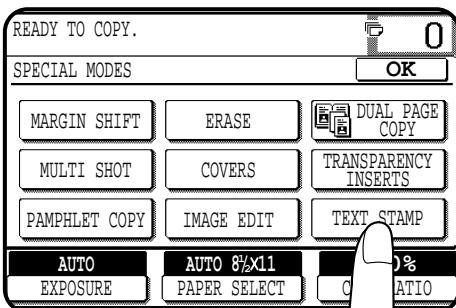

3 Press the “TEXT STAMP” key on the touch panel.

- The TEXT STAMP menu will appear.

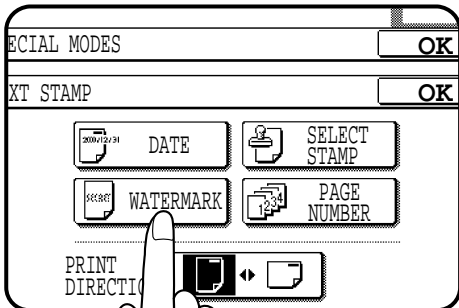

- 4** Press the “WATERMARK” key on the touch panel.
- The setting screen for WATERMARK will appear.

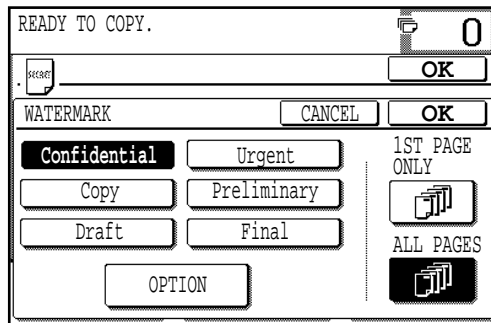

- 5** Select the desired watermark to be printed.
- The selected watermark will be highlighted.

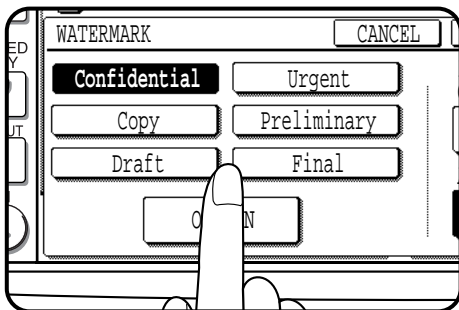

- 6** Select the pages to be printed with the watermark.
- Indicate whether the watermark is to be printed only on the first page or on all pages, by pressing the “1ST PAGE ONLY” or “ALL PAGES” key.

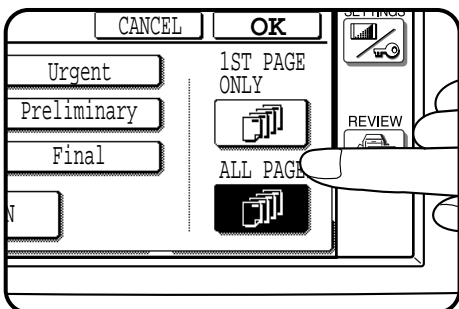

- 7** To adjust the exposure, press the “OPTION” key. Otherwise, proceed to step 9.
- The following screen will appear.

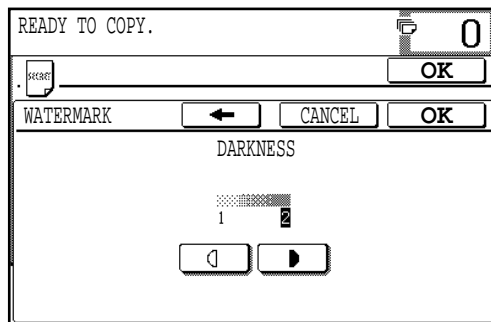
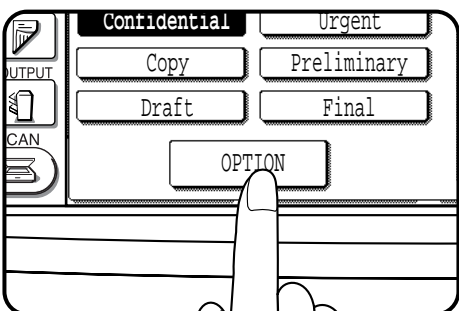

- 8** Adjust the darkness of the watermark.
- Press the key to darken or the key to lighten.
 - To return to the previous screen, press the key.

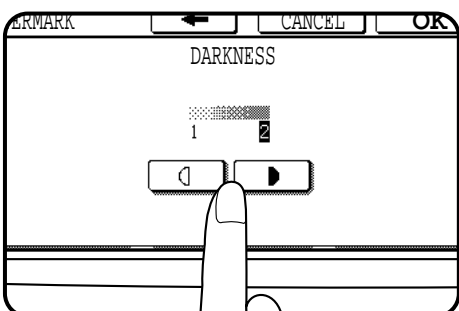

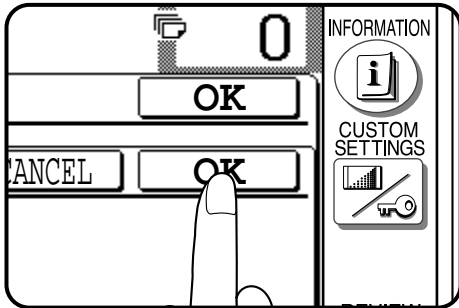

9 Press the lower “OK” key.

- The TEXT STAMP menu will appear again.

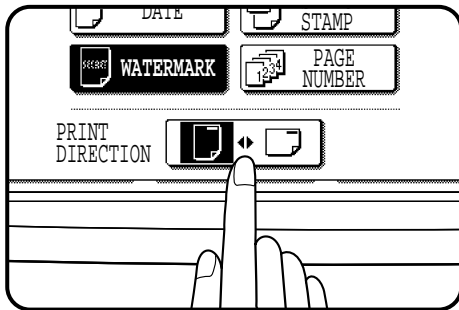

10 Select the print direction.

- If the PAMPHLET COPY function is used with this function, the portrait orientation (📄) must be selected.

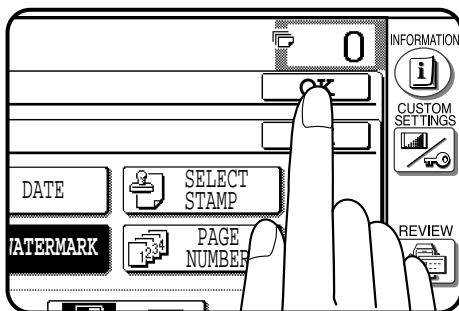

11 Press the upper “OK” key.

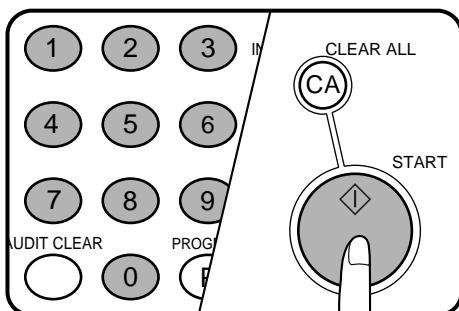

12 Make all other desired copier selections and enter the desired number of copies.

13 Press the START key.

- If the document feeder is used, scanning of originals and copying will start.
- If the document glass is used, proceed to the next step.

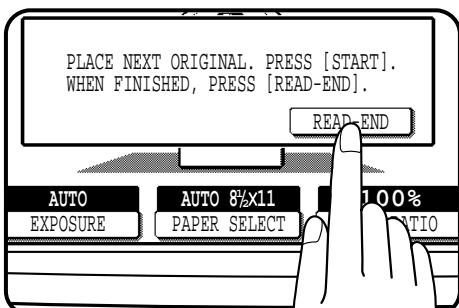

14 Replace the finished original with the next original after the START key indicator lights up, and then press the START key. Repeat this step until all originals have been scanned. Then, press the “READ-END” key on the touch panel.

- Copying will start at this time.
- Up to 120 sheets of 8-1/2" x 11" originals or up to 60 sheets of originals larger than 8-1/2" x 11" can be scanned.
- To cancel the WATERMARK function, select the WATERMARK function again and press the “CANCEL” key.

PAGE NUMBER

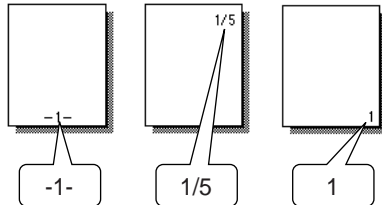

The PAGE NUMBER function adds page numbers to the copies.

- The page number format can be selected from three types.
- The page number print position is automatically selected depending on the selected page number format.
- If reduction or enlargement is used with this function, the print position may move or the page numbers may not be printed.

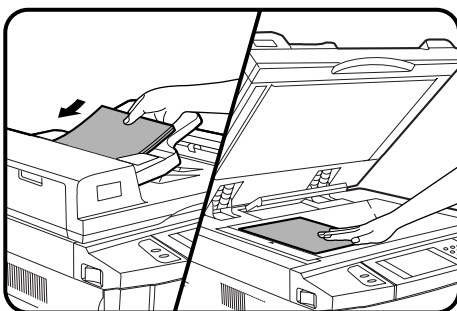

1 Place the originals in the document feeder tray or on the document glass.

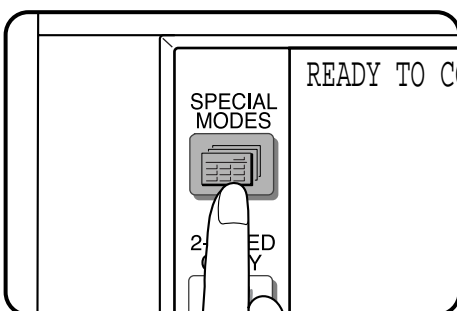

2 Press the SPECIAL MODES key.
 • The SPECIAL MODES screen will appear.

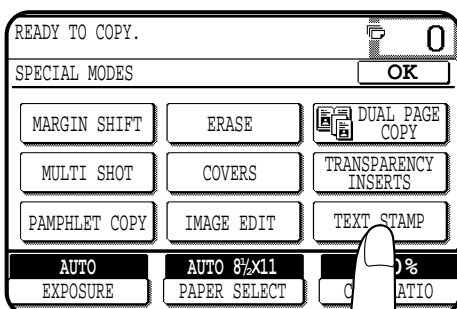

3 Press the “TEXT STAMP” key on the touch panel.
 • The TEXT STAMP menu will appear.

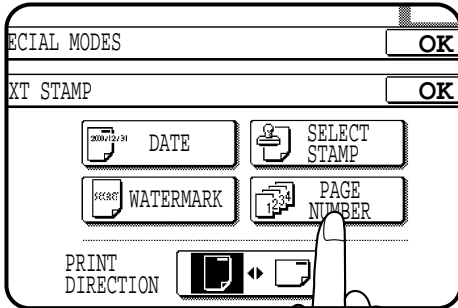

- 4** Press the “PAGE NUMBER” key on the touch panel.
- The setting screen for PAGE NUMBER will appear.

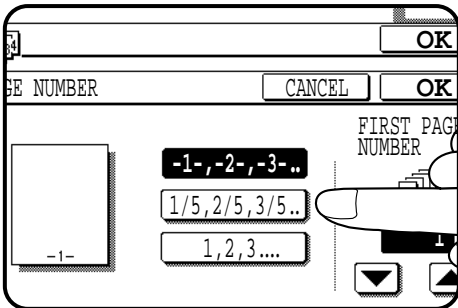
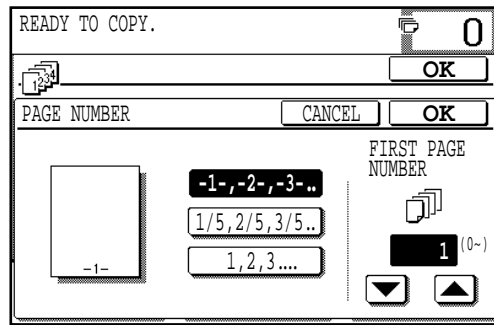

- 5** Select the desired page number format.
- The selected page number format will be highlighted.

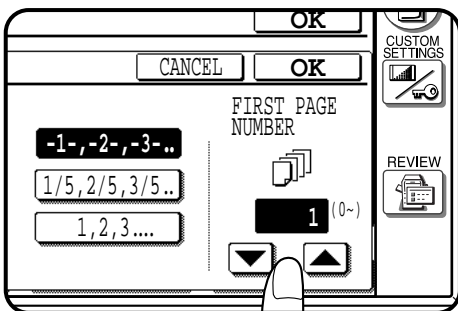

- 6** Select the starting page number.
- Use the ▼ or ▲ key to increment or decrement the page number.
 - If the page number format “1/5, 2/5, 3/5..” has been selected in step 5, the starting page number is fixed to 1 and cannot be changed.

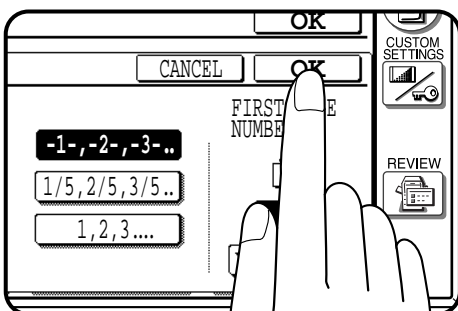

- 7** Press the lower “OK” key.
- The TEXT STAMP menu will appear again.

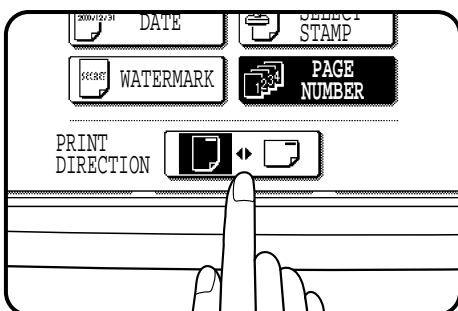

- 8** Select the print direction.
- If the PAMPHLET COPY function is used with this function, the portrait orientation (📄) must be selected.

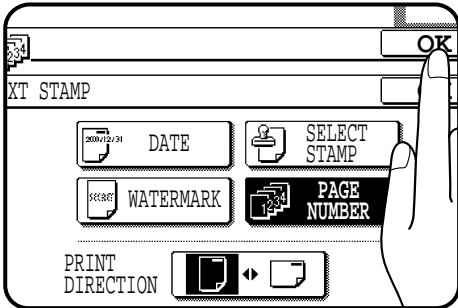

9 Press the upper “OK” key.

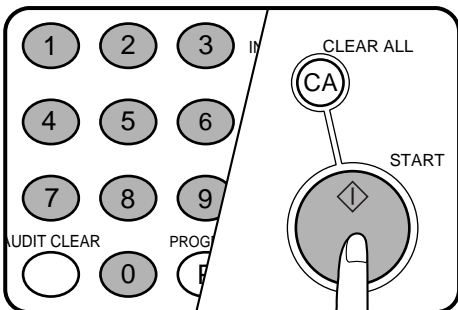

10 Make all other desired copier selections and enter the desired number of copies.

11 Press the START key.

- If the document feeder is used, copying will start after all originals are scanned.
- If the document glass is used, proceed to the next step.

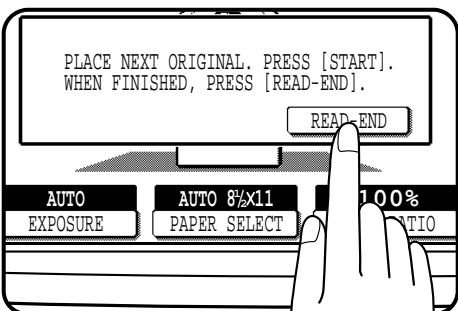

12 Replace the finished original with the next original after the START key indicator lights up, and then press the START key. Repeat this step until all originals have been scanned. Then, press the “READ-END” key on the touch panel.

- Copying will start at this time.
- Up to 120 sheets of 8-1/2" x 11" originals or up to 60 sheets of originals larger than 8-1/2" x 11" can be scanned.
- To cancel the PAGE NUMBER function, select the PAGE NUMBER function again and press the “CANCEL” key.

TANDEM COPY

If this copier is connected with another copier of the same model equipped with the same options through the tandem-connection cable (AR-CA1), copying with the two machines can be performed eventually making the total copy time for multiple copies one-half of the case when using a single copier.

- A dedicated tandem-connection cable AR-CA1 is required for tandem copying.
- The tandem copying can be used only in the sort mode or staple sort mode. The group mode cannot be selected.
- The transparency inserts function cannot be used with this function because the number of copies must be 1 when the transparency inserts function is used.
- The TANDEM COPY key will only be displayed on the touch panel of the machine set as the main copier, (an authorized Sharp Service Technician will do the setting of the main and sub copiers at the time of installation). When the tandem function is selected, (only available on the main copier) the other will then become the sub copier. The setting procedure is described below.

- INTERRUPT will not function during tandem copying.
- The tandem copying function is not available for the AR-287.

CHAPTER 3

SPECIAL FUNCTIONS Tandem copy

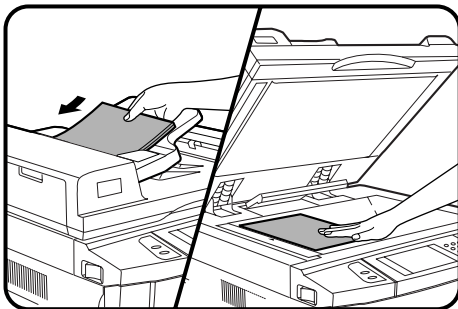

1 Ensure that the two copiers are connected through the tandem-connection cable and they have been turned on.

2 On the copier that will be set as the main copier, place the originals in the document feeder tray or on the document glass.

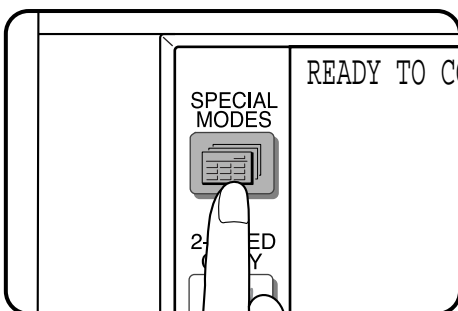

3 Press the **SPECIAL MODES** key.

- The SPECIAL MODES screen will appear.

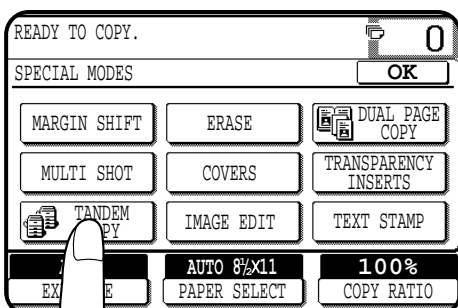

4 Press the **“TANDEM COPY”** key on the touch panel.

- The **“TANDEM COPY”** key will be highlighted.

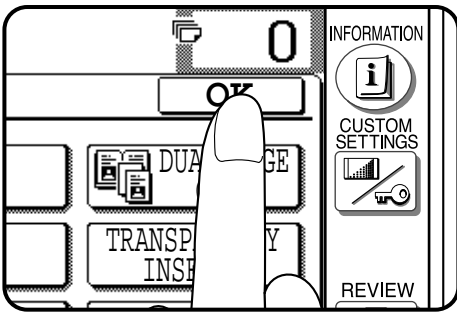

5 Press the “OK” key.

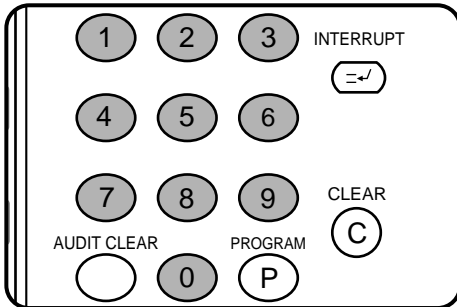

6 Make all other desired copier settings and enter the number of copies.

- The functions selected on the main copier will be used by both copiers.
 - (1) The key operator programs of which settings at the main copier are given priority (the settings at the sub copier are disregarded):
Exposure Adjustment, Toner Save Mode, Initial Margin Shift, Erase Width Adjustment, Initial Status Setting, Staple Position Setting, Date Format Setting, Date and Time Adjustment and Disabling of Covers Mode.
 - (2) The key operator programs for which the same settings between the main and sub copiers are required:
Disabling of Duplex Copying and Disabling of Stapler .
 - (3) The key operator program that can only be set at the main copier:
Disabling of Auto Paper Selection.
 - (4) In case of the other key operator programs than mentioned above, different settings on the main and sub copiers respectively do not matter even when the tandem copying is activated.

7 Ensure that paper of the same size selected in the main copier is installed in the sub copier.

- Paper of the same size and same orientation must be installed in the two copiers. Even if the image of the original is rotated to match the copy paper in the main copier, the orientation of the copy paper in the sub copier must be the same as that in the master copier.

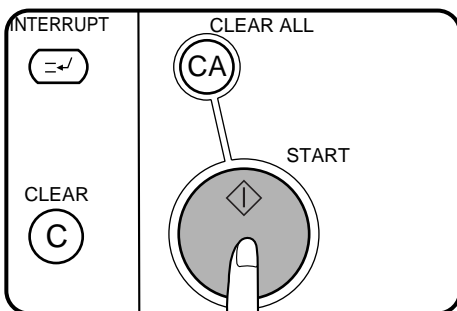

8 On the main copier, press the **START** key.

- Images scanned by the main copier will be stored in both copiers. Half the number of copies selected will be made simultaneously on both copiers. When the number of copies selected is odd, one more copy will be made on the main copier than the sub copier.
- If the message “**CHECK THE SUB MACHINE.**” appears on the main machine, an error has occurred in the sub machine. Check the message on the sub machine and clear the error.
- If the message “**THE SYSTEM IS NOT CONFIGURED TO PERFORM TANDEM JOB. CODE: XX**” appears on the main machine, refer to the tandem copy related descriptions in the TROUBLESHOOTING (see page 5-13).
- To cancel a copy run after starting, press the CLEAR ALL (CA) key on the main copier.
- To cancel the TANDEM copying, press the “TANDEM COPY” key again on the SPECIAL MODES screen of the main copier.

SETTING REVIEW

The current settings of copier functions can be displayed on the touch panel.

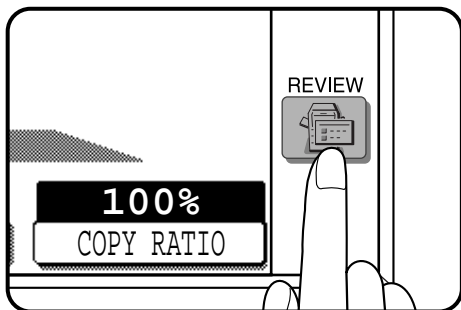

1 Press the REVIEW key.

- The REVIEW screen will appear.

The settings of the duplex mode (1-sided to 1-sided, etc.), sort/group mode, and special functions will be displayed. The exposure, paper size, and copy ratio which are displayed on the basic screen will not be displayed on the REVIEW screen.

Example

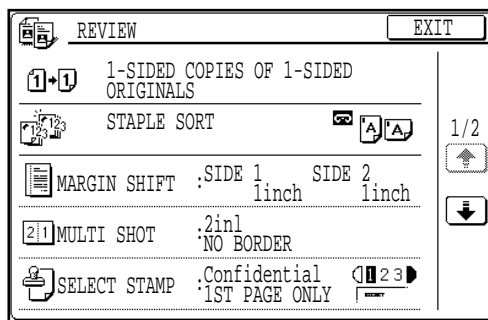

2 To review all setting information, it may be necessary to scroll between review screens. To scroll between screens, use the or key.

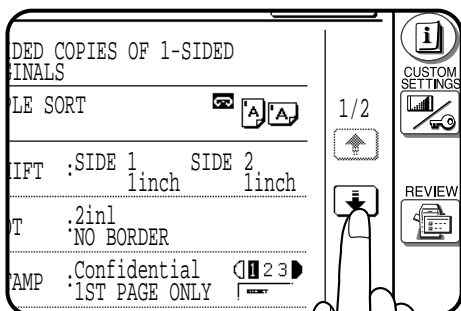

3 To exit the review screen, press the “EXIT” key.

- The basic screen will appear again.

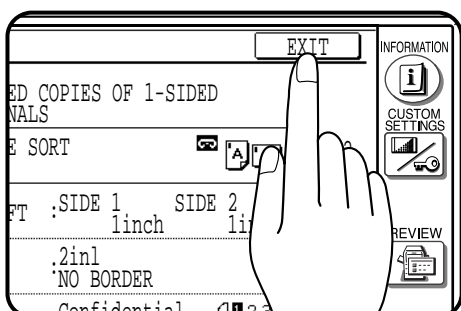

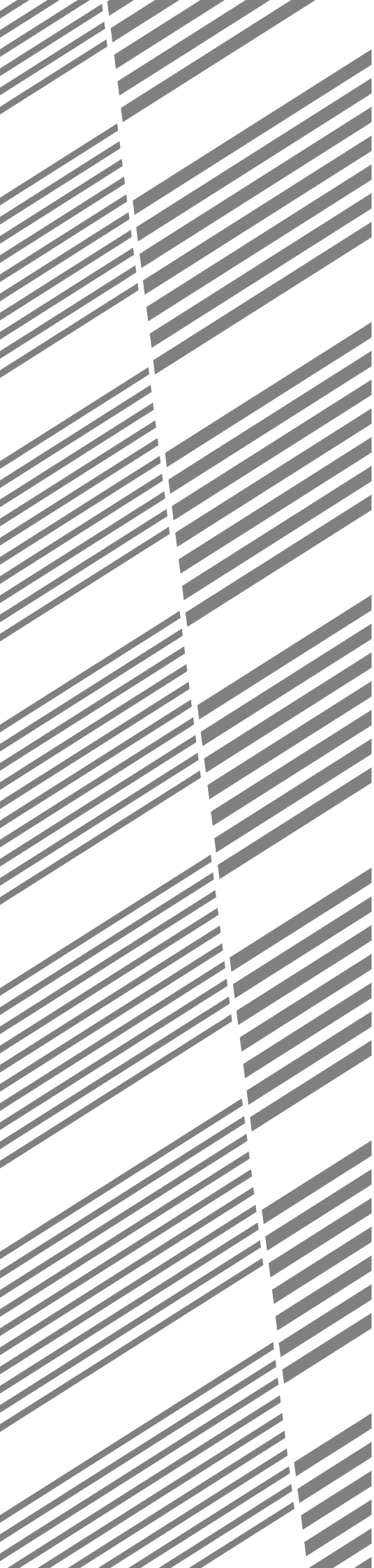

CHAPTER 4

SUPPLIES

This chapter describes the supplies for this copier such as paper and toner.

	Page
• PAPER	4-2
Types and sizes of copy paper	4-2
Loading copy paper	4-2
• ADDING TONER	4-5
• USED TONER DISPOSAL	4-7
• STORAGE OF SUPPLIES	4-8



PAPER

Types and sizes of copy paper

	Size	Weight	Capacity (20 lb. bond paper)	Special paper
Paper trays 1 and 2	5-1/2" x 8-1/2" to 11" x 17"	15 lbs. to 28 lbs.	500 sheets	
Bypass tray	5-1/2" x 8-1/2" to 11" x 17"	14 lbs. to 34 lbs.* (Ordinary paper)	50 sheets	Transparency film, labels, tracing paper, 65 lb. paper**, 110 lb. paper**

- For best results, use only paper recommended by SHARP.
- * For paper weighing from 28 to 34 lbs., 8-1/2" x 11" is the maximum size that can be fed through the bypass tray.
- ** Paper heavier than 34 lbs. must be fed narrow side into the feed slot of the bypass tray.

Loading copy paper

"OPEN TRAY AND ADD PAPER." will be displayed when there is no copy paper in a selected paper feed station.

When a selected paper tray is not installed or is improperly installed, "PUSH PAPER TRAY INTO THE MACHINE UNTIL IT LATCHES." will be displayed. Install it or push it back firmly into place.

For best results, use only Sharp recommended paper.

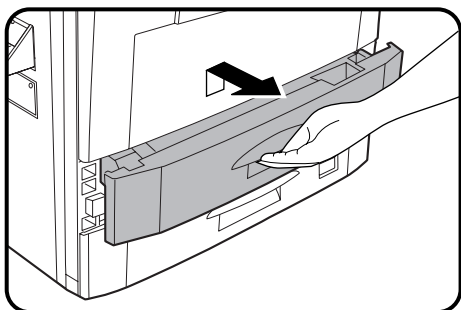
Loading paper in paper trays 1 and 2

1 Gently lift and pull out the paper tray.

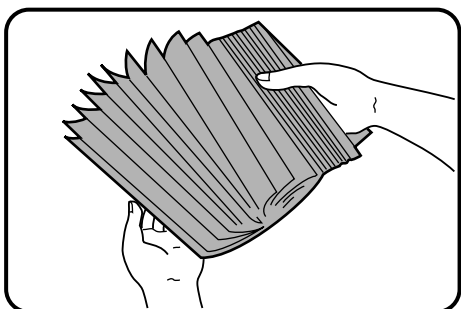

2 Fan the copy paper and insert it into the tray.

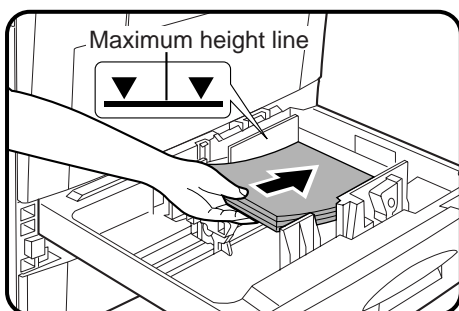

- The tray holds 500 sheets of 20 lb. bond paper.
Do not load paper above the maximum height line.

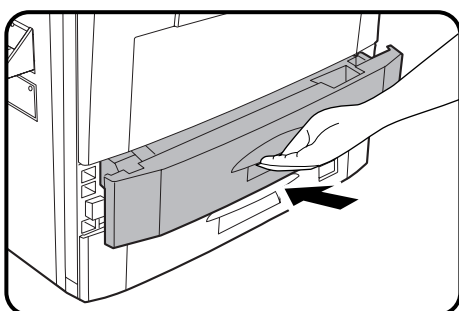

3 Push the paper tray firmly back into the copier.

Changing the copy paper size in the tray

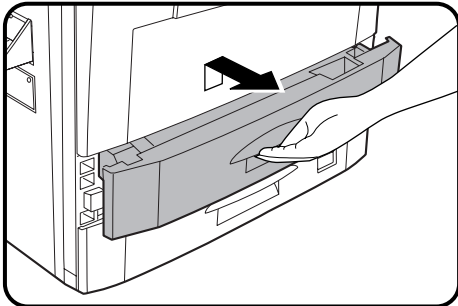

1 Gently lift and pull out the paper tray until it stops.

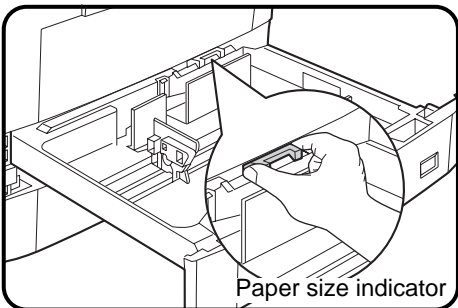

2 Adjust the paper size indicator to match the paper size to be set.

- Slide the paper size indicator to the right or left to match the paper size.

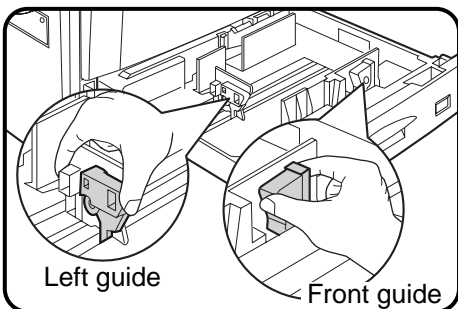

3 Adjust the front guide and left guide while squeezing their lock levers.

- Slide the front and left guides to match the width and length of the copy paper.

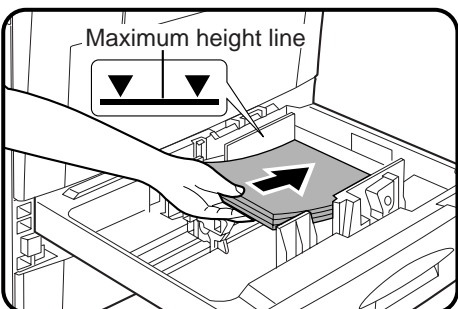

4 Load copy paper into the tray.

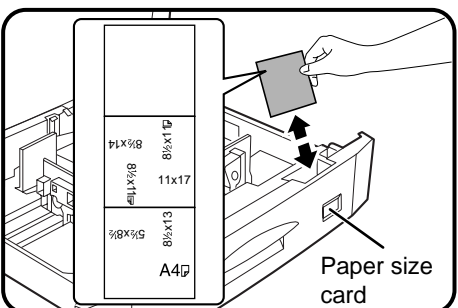



5 Place the paper size card in the front of the paper tray.

- The paper size card has three faces. Fold the card properly to show the selected paper size. The paper size indication which shows through the slot on the front of the copier should match the selected paper size.

6 Push the paper tray firmly back into the copier.

ADDING TONER

The message “(TONER SUPPLY IS LOW. PRESS  FOR GUIDANCE.)” will appear in the message display before the toner supply is completely empty. If copying is continued, copies will gradually become lighter until the copier stops and the message display changes to “ADD TONER. PRESS  FOR GUIDANCE.” indicating that the toner supply is empty. Toner can be added any time after the message “(TONER SUPPLY IS LOW. PRESS  FOR GUIDANCE.)” appears. To add toner, stop the copier and proceed as below. When either message appears, you can use the INFORMATION key for detailed information as necessary.

During long copy runs of multiple originals containing many images and/or dark shades, “TONER REPLENISHMENT IN PROGRESS.” will appear and the copier will stop making copies even though toner is left. The copier will automatically cycle and replenish the toner to the normal level and then the START key indicator will light up. Press the START key to resume copying.

For best copying results, be sure to use only Sharp Genuine Supplies which are designed, engineered, and tested to maximize the life and performance of Sharp copiers.

Look for the Genuine Supplies label on the toner package.

SHARP

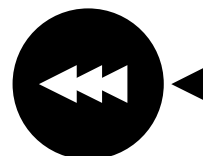

GENUINE SUPPLIES

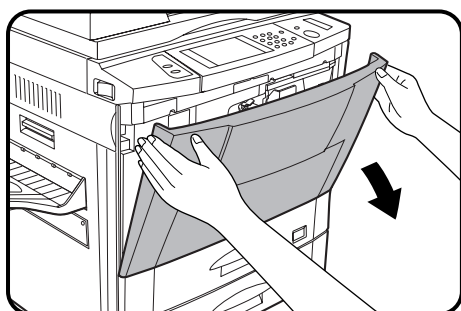

1 Open the front cover.

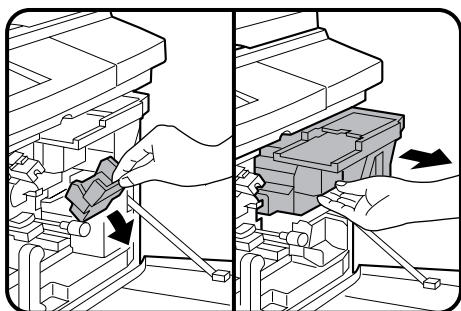

2 Pull down the toner hopper lock lever and pull the toner hopper out slowly until it stops.

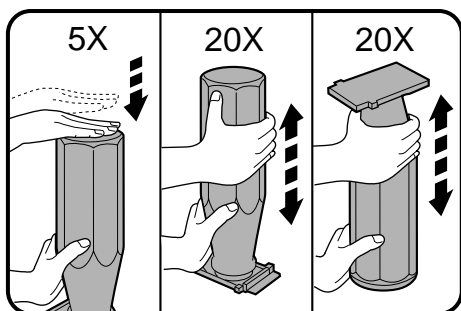

3 Tap on the top of the toner cartridge 5 times. Hold the new toner cartridge vertically and vigorously shake it up and down about 20 times, then invert the cartridge and again shake it up and down about 20 times. This will loosen the toner and allow it to flow more easily into the toner hopper.

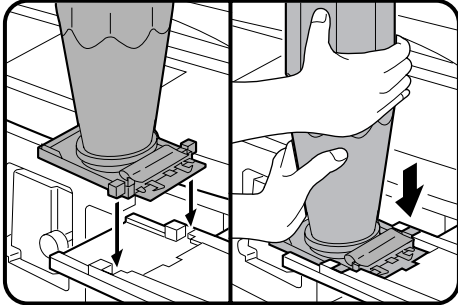

4 Place the new toner cartridge with the tabs in the notches as shown.

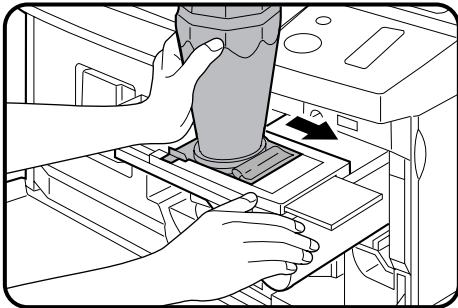

5 Slide the toner cartridge along the guides over the toner hopper.

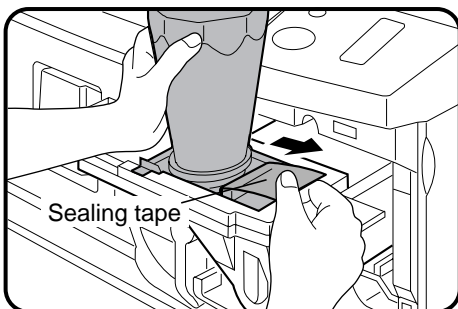

6 Hold the toner cartridge with one hand while pulling on the sealing tape to remove it.

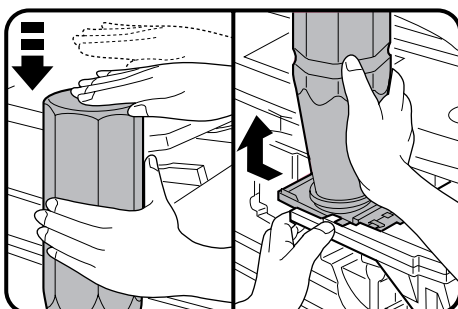

7 Tap on the top of the toner cartridge 5 times to start the flow of toner into the toner hopper.

- If the toner cartridge was sufficiently shaken as described in step 3, it will take about 50 seconds for the cartridge to empty. Do not remove the cartridge until it is empty. If not empty, tap on the top of the cartridge again until empty.

8 Slide the empty toner cartridge back along the guides and remove it.

- The cartridge opening will be closed as it is moved back along the guides.

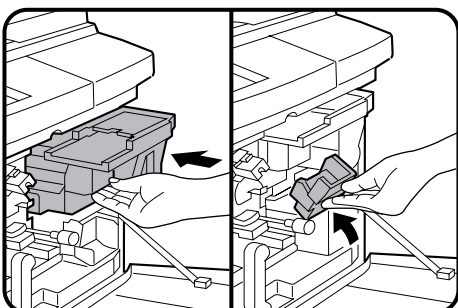

9 Slide the toner hopper into the copier and return the toner hopper lock lever into place.

10 Close the front cover.

NOTE:
Add only one cartridge of toner.

USED TONER DISPOSAL

“REPLACE USED TONER CONTAINER. PRESS **i** FOR GUIDANCE.” will appear when the toner collecting container is full. The copier will stop and will not operate until a new container has been installed. Replace the toner collecting container as described below. When the above message is displayed, you can use the INFORMATION key for detailed information as necessary.

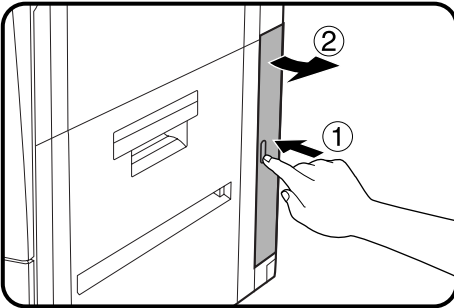

- 1 Open the toner collecting container cover.**
 - Push once on the door to unlatch and open it.

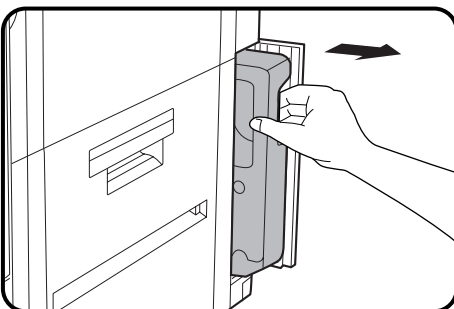

- 2 Disengage and remove the container from the copier.**
 - Toner cannot be reused. Do not transfer used toner to the toner hopper.
 - Remove the cap from a new toner collecting container and use it to cover the full toner collecting container.
 - Keep the full toner collecting container until the next regular service call. Your authorized Sharp Service Technician will collect the container for disposal.

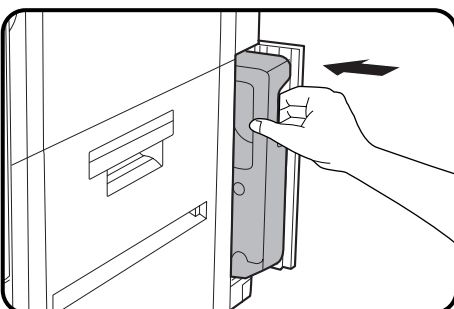

- 3 Install a new toner collecting container until it clicks into place.**

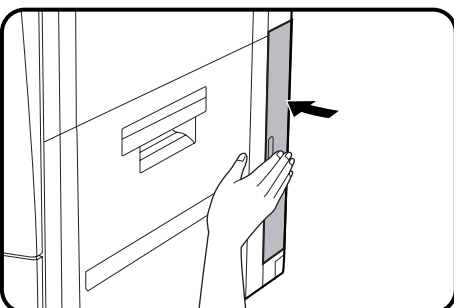

- 4 Close the toner collecting container cover.**

STORAGE OF SUPPLIES

The supplies of this copier replaced by the user include copy paper, toner, toner collecting container, and staple cartridges for the optional finishers (AR-FN1N, AR-FN2).

For best copying results, be sure to use only Sharp Genuine Supplies which are designed, engineered, and tested to maximize the life and performance of Sharp copiers. Look for the Genuine Supplies label on the toner package.

SHARP

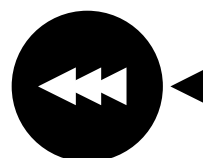

GENUINE SUPPLIES

Photoconductive drum

The AR-287/AR-337/AR-407 Copiers have advanced process control technology which improves copy quality uniformity. This feature stabilizes copy quality throughout the life of the photoconductive drum by automatically compensating for the changes in drum characteristics due to wear, operator use patterns, and environmental conditions. The automatic adjustments are made in response to a sensor that detects the reflectance characteristics of the drum.

WARNING

This feature requires drums containing the special reflectance area (recommended Sharp genuine photoconductive drum), to prevent low image density copies from poor process control and possible damage to the machine. If you use other drums, the process control system cannot run properly.

Proper storage

- 1 Store the supplies in a location that is:**
 - clean and dry,
 - at a stable temperature,
 - not exposed to direct sunlight.

- 2 Store copy paper in the wrapper and lying flat.**
 - Paper stored in packages standing up or out of the wrapper may curl or become damp, resulting in paper misfeeds.

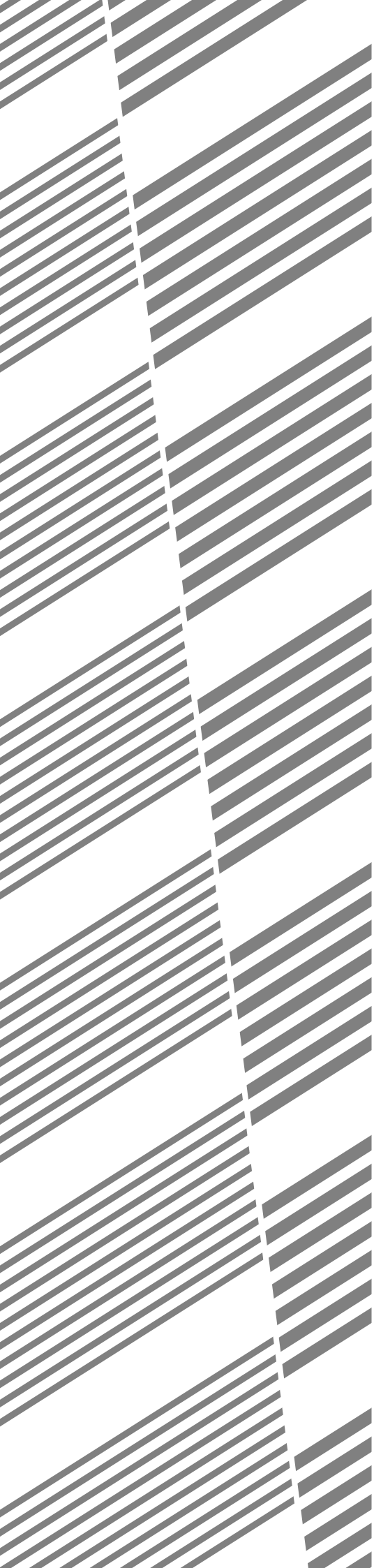

CHAPTER 5

COPIER TROUBLE?

This chapter describes how to remove misfed originals and paper and other common trouble remedies.

	Page
• MISFEED REMOVAL	5-2
• MAINTENANCE REQUIRED	5-11
• TROUBLESHOOTING	5-12

MISFEED REMOVAL

When a misfeed occurs, the copier will stop.

The message "A MISFEED HAS OCCURRED. CLEAR INDICATED AREA. PRESS  FOR RECOVERY INSTRUCTIONS." will appear with a display of paper misfeed locations. Press the INFORMATION key for more detailed information as necessary.

If paper becomes accidentally torn during removal, be sure to remove all pieces. Be careful not to damage the photoconductive drum or the corona wires.

First confirm the misfeed locations.

For misfeeds in optional equipment, see their respective sections. (pages 7-14, 7-28, 7-32, and 7-36)

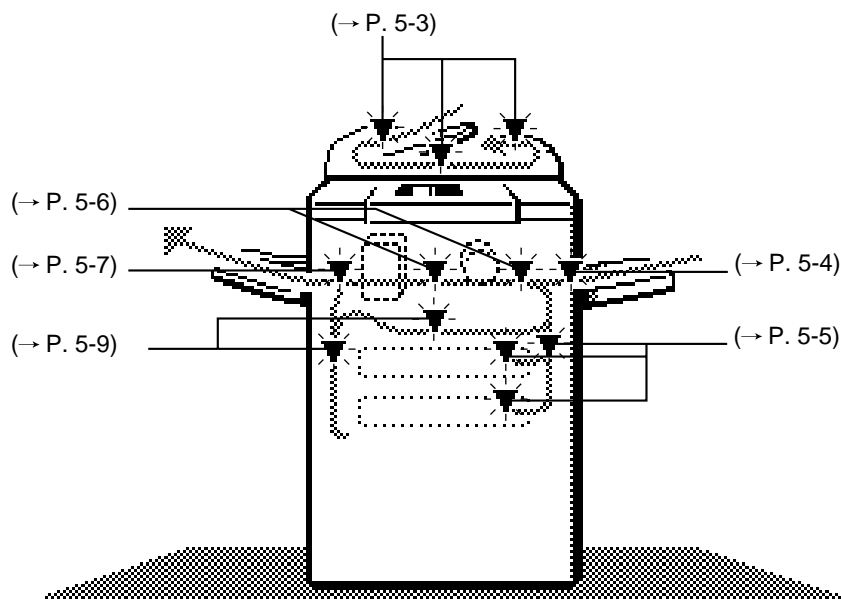

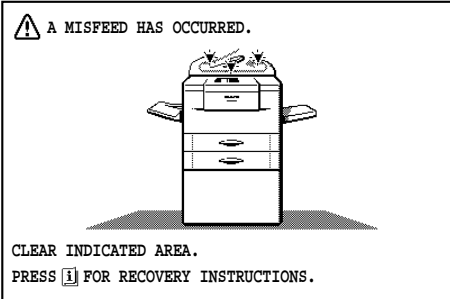

Misfeed in the RADF

When the RADF misfeeds an original sheet, the copier will stop and the misfeed message will appear.

An original misfeed may occur at one of three locations: (A) in the RADF feed section, (B) in the exit roller, or (C) under the transport belt.

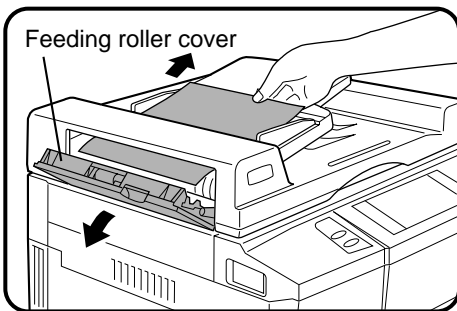
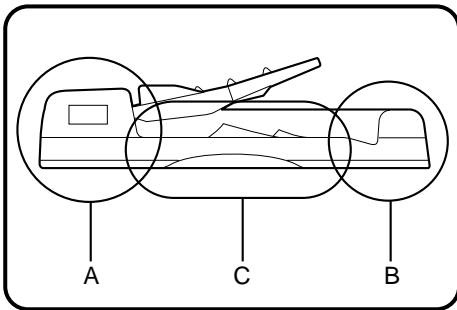

- (A) Open the feeding roller cover and pull the original gently to the right and out from the document feeder tray.
- Be sure to open and close the document feeder cover to cancel the misfeed display.

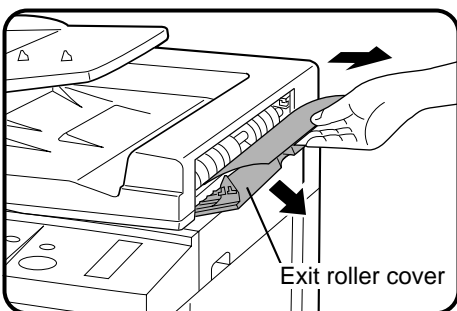

- (B) Open the exit roller cover and gently pull the original out.
- Be sure to open and close the document feeder cover to cancel the misfeed display.

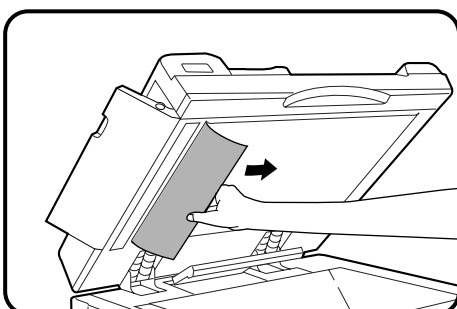

- (C) Open the feeding roller cover and the document feeder cover, and remove the original.

NOTE:

After misfed originals are removed from locations A, B and/or C, a message may appear indicating the number of originals which must be returned to the document feeder tray. Return the originals and press the START key to resume copying.

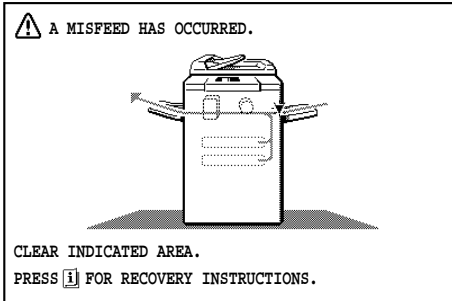

Misfeed in the bypass tray

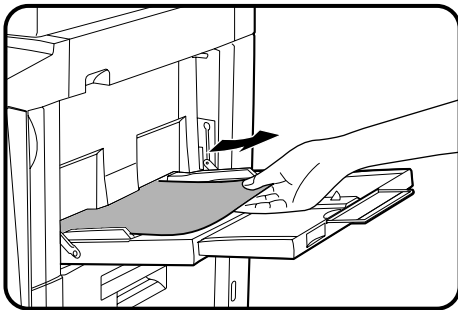

1 Gently pull the misfed paper out.

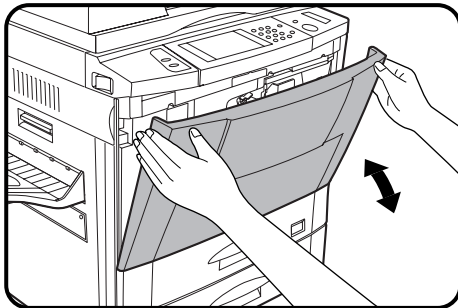

2 Open and close the front cover to cancel the misfeed display.

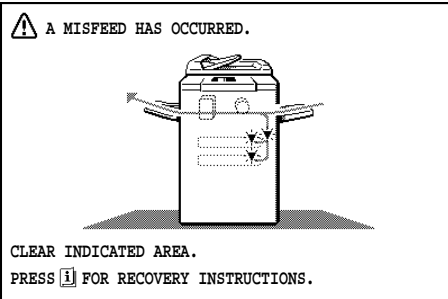

Misfeed in paper trays 1 and 2

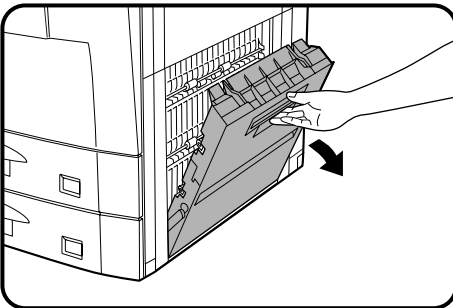

1 Open the right side cover.

- Hold the handle and gently open the cover.
- If any paper is set in the bypass tray, remove the paper and close the bypass tray before opening the right side cover.

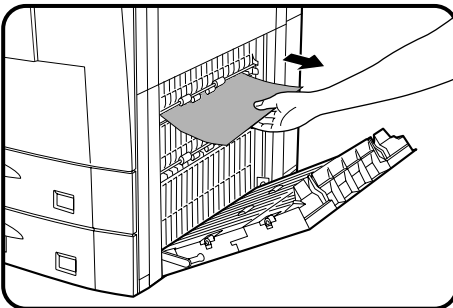

2 Remove the misfed paper.

- Be careful not to tear the misfed paper during removal.

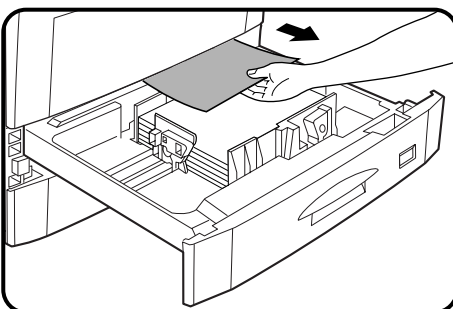

3 If the paper cannot be seen from the side, pull out the paper tray which was in use and remove the misfed paper.

- Be careful not to tear the misfed paper during removal.

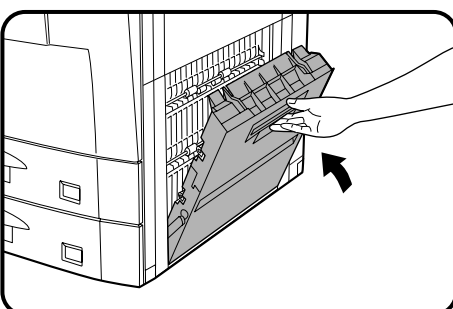

4 Close the paper tray and the side cover.

5 Open and close the front cover to cancel the misfeed display.

- Confirm that the misfeed display is cleared.

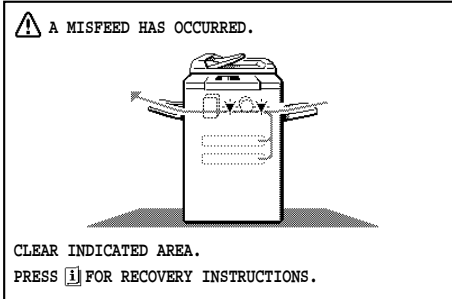

Misfeed in the transport area

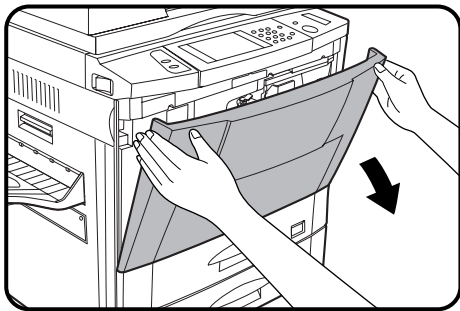

1 Open the front cover.

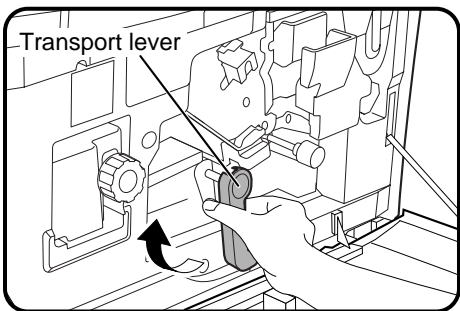

2 Remove the misfed paper.

① Turn the transport lever to the left.

CAUTION

The area behind the transport lever is hot.
Use sufficient care in handling this lever.

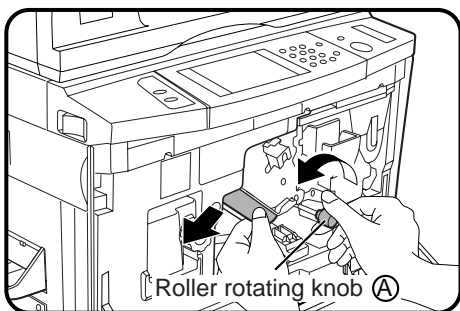

② Turn roller rotating knob (A) in the direction of the arrow to remove the misfed paper.

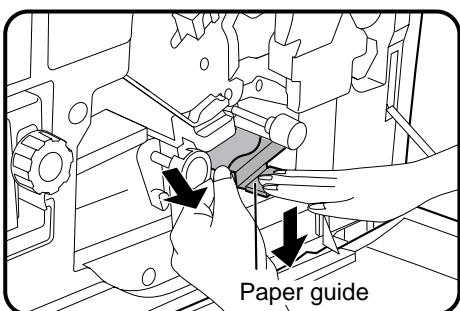

• Push down the paper guide and remove any misfed paper.

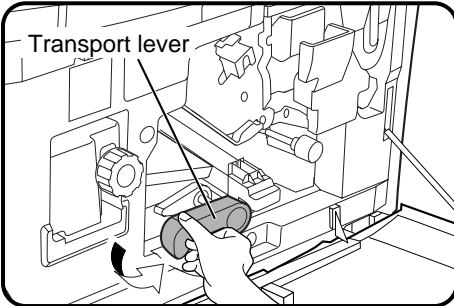

③ Turn the transport lever back into place.

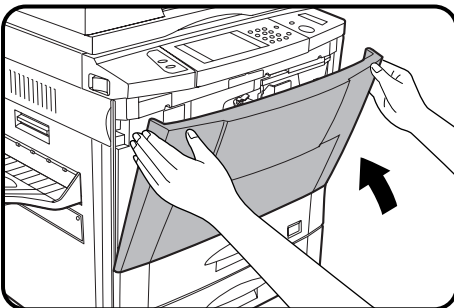

3 Close the front cover.
 • Confirm that the misfeed display is cleared.

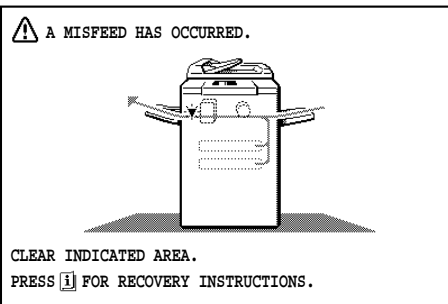

Misfeed around the fusing unit and exit area

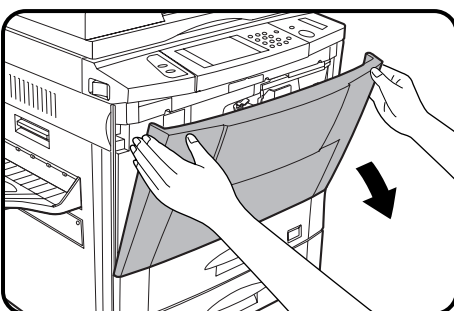

1 Open the front cover.

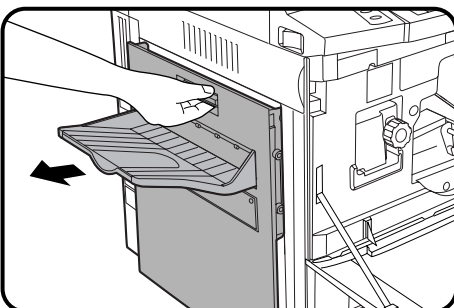

2 Open the exit area cover carefully.

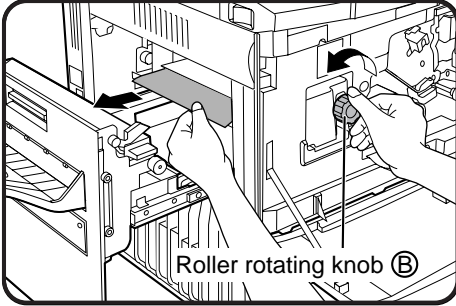

3 Remove the misfed paper.

If the misfed paper is in the inner part of the exit area:

- ① Turn roller rotating knob (B) in the direction of the arrow and remove the paper.

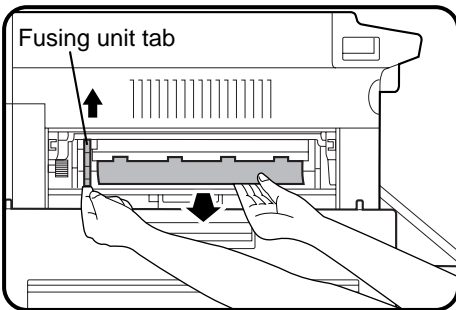

- ② If the misfed paper is deep in the fusing unit, lift the fusing unit tab and remove any misfed paper.

CAUTION

The fusing unit is hot! Be sure to touch only the green tab or the green roller rotating knob.

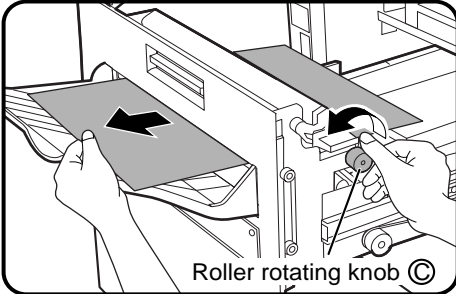

If the misfed paper is in the exit area:

- ① Turn roller rotating knob (C) in the direction of the arrow and remove the paper.

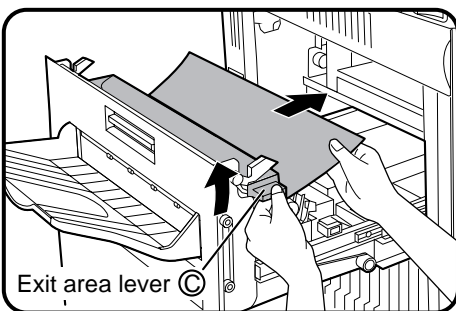

- ② If the misfed paper cannot be removed in step ①, raise exit area lever (C) and remove the paper.

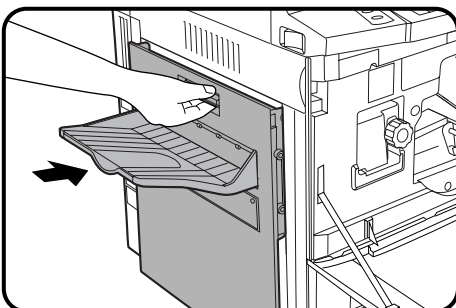

4 Close the exit area cover.

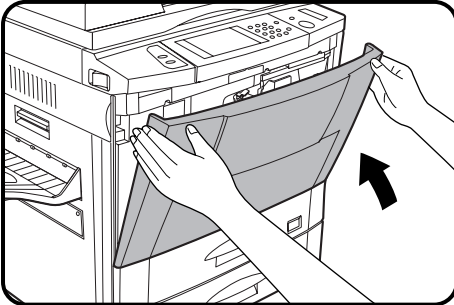

- 5 Close the front cover.**
- Confirm that the misfeed display is cleared.

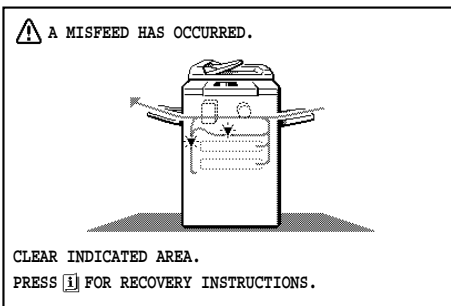

Misfeed in the duplex module

If the misfed paper is in the duplex module or the section below the exit area:

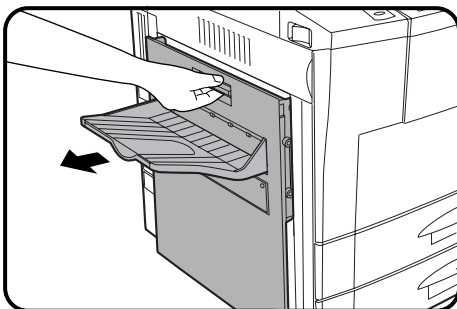

- 1 Open the exit area cover carefully.**

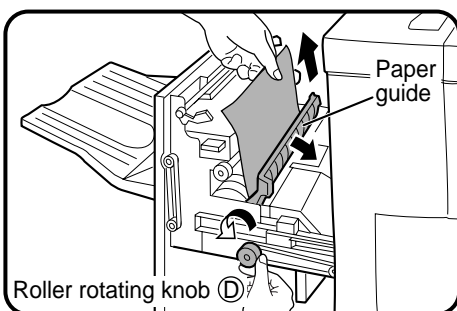

- 2 Remove the misfed paper.**
- ① Open the paper guide, turn roller rotating knob (D) in the direction of the arrow and remove the misfed paper. Close the paper guide.

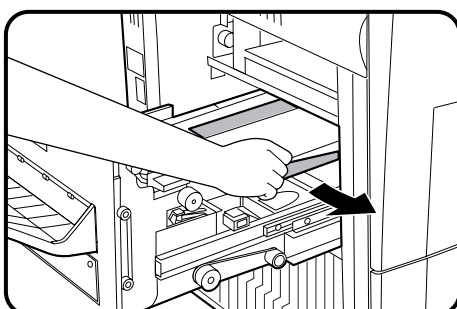

- ② Remove any misfed paper from the duplex module.
 - Be careful not to tear the misfed paper during removal.

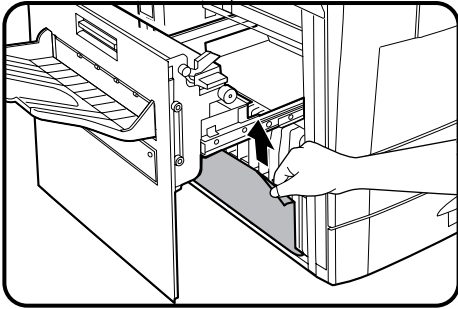

- ③ Remove the misfed paper from the section below the exit area.

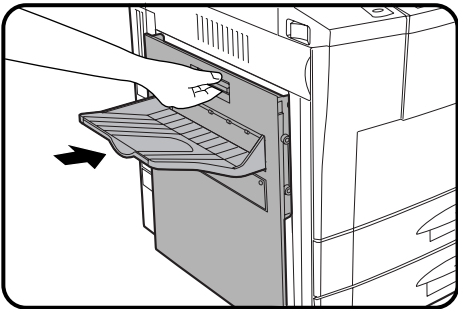

- 3** Close the exit area cover.

- 4** Open and close the front cover to cancel the misfeed display.

If the misfed paper is in the right side of the duplex module:

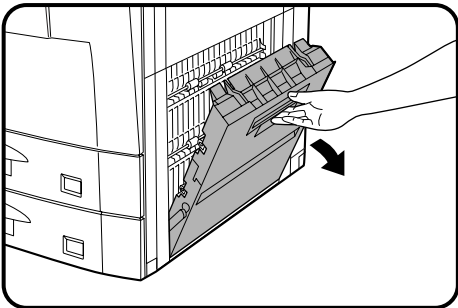

- 1** Open the right side cover.

- Hold the handle and gently open the cover.
- If any paper is set in the bypass tray, remove the paper and close the bypass tray before opening the right side cover.

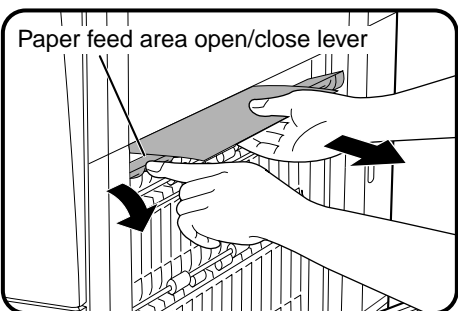

- 2** Remove the misfed paper.

- Open the paper feed area open/close lever in the direction of the arrow and remove the misfed paper.

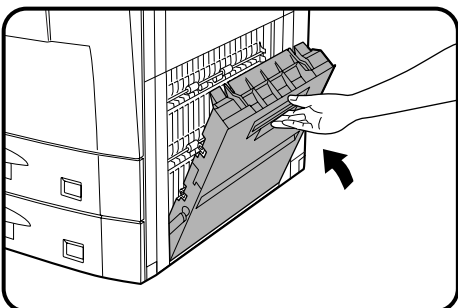

- 3** Close the right side cover.

- 4** Open and close the front cover to cancel the misfeed display.

- Confirm that the misfeed display is cleared.

MAINTENANCE REQUIRED

When the message “**READY TO COPY. (MAINTENANCE REQUIRED)**” appears in the message display, service by an authorized Sharp Service Technician will be required soon. Contact your Service Center as soon as possible.

TROUBLESHOOTING

Always check the message display whenever the copier stops or operation is not possible. The messages will give you easy-to-follow directions. If the messages do not give specific instructions, check the list below.

Problem	Solution	
Copier does not operate.	● Copier plugged in?	Plug the copier into a grounded outlet.
	● Power switch on?	Turn the power switch on.
Copies are too dark or too light.	● Copy density properly adjusted?	See page 2-16.
Blank copies.	● Is the original placed face up in the document feeder tray or face down on the document glass?	Place the original face up in the document feeder tray or face down on the document glass.
Copies smear if rubbed.	● Paper too heavy?	Use copy paper within the specified range. See page 4-2.
	● Paper damp?	Replace with dry copy paper. Be sure to store copy paper in a dry location.
Copy size is different from the selected paper size.	● Paper size indicator properly set?	When changing the copy paper size in a tray, be sure to adjust the paper size indicator. See page 4-4.
Paper misfeeds frequently.	● Non-standard paper used?	Use standard paper. If using special papers, feed the paper through the bypass tray.
	● Is paper properly installed?	See pages 2-14 and 4-2.
	● Pieces of paper inside copier?	Remove all pieces of misfed paper. See page 5-2.
	● Paper curled or damp?	Store copy paper flat in the wrapper in a dry location. See page 4-8.

Problem	Solution	
Dust, dirt, smudges appear on copies.	<ul style="list-style-type: none"> Document glass, RADF transport belt dirty? 	Clean regularly. See page 6-6.
Touch panel is too dark or too light.	<ul style="list-style-type: none"> Is LCD contrast properly adjusted? 	Adjust the LCD contrast. See page 6-7.
“CHECK THE SUB MACHINE.” message appears and the tandem copying does not start.	<ul style="list-style-type: none"> Some message appears on the touch panel of the sub copier? 	Follow the message on the sub copier to solve the problem.
“THE SYSTEM IS NOT CONFIGURED TO PERFORM TANDEM JOB. CODE: XX” message appears and the tandem copying can not be performed.	<ul style="list-style-type: none"> The same options are equipped for the main and sub copiers? 	Tandem copying is not performed unless the same options are equipped for both main and sub copiers.
	<ul style="list-style-type: none"> The settings in the following key operator programs are different on the main and sub copiers: <ul style="list-style-type: none"> * Disabling of Duplex Copying (error code No. 51) * Disabling of Stapler (error code No. 52) * Disabling of Bypass-Tray When Offset Tray Selected (error code No. 53: only with AR-FN2) 	Tandem copying is not performed unless the settings in these key operator programs are the same on both main and sub copiers.

If a problem persists after checking the above, please consult your authorized Sharp Service Center.

Self-diagnostic function

An automatic self-diagnostic function is built into this copier. Should the copier malfunction, the self-diagnostic function will locate the problem and stop the copier to prevent damage. An alphanumeric code will appear in the message display.

Example

Should the copier stop completely, and the message “CALL FOR SERVICE. CODE: □□” appear in the message display, contact your authorized Sharp Service Center.

★ **KEY OPERATOR** See page 29 of the **KEY OPERATOR’S GUIDE**.

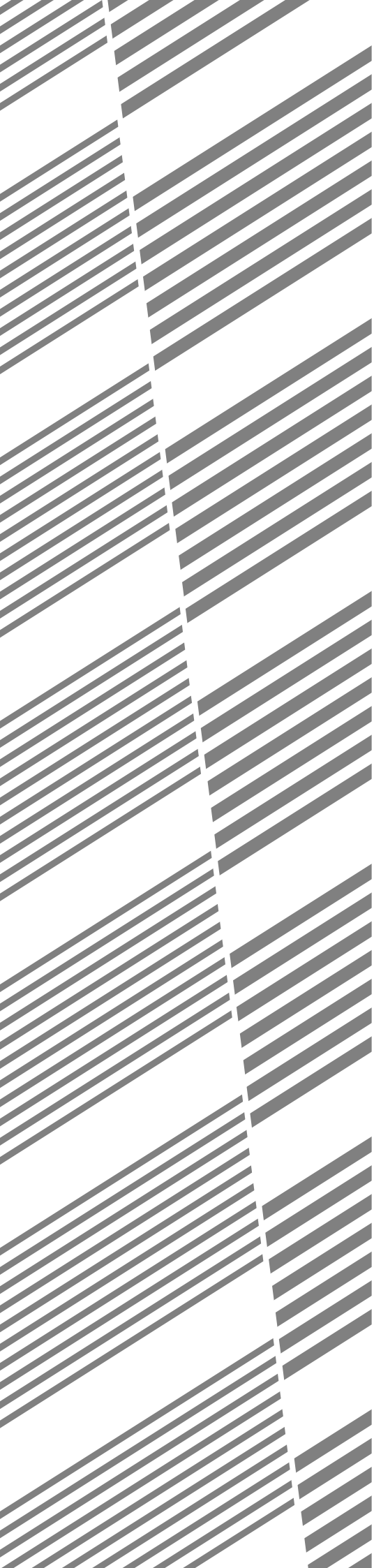

CHAPTER 6

GENERAL INFORMATION



This chapter describes general information for using this copier.

	Page
• PART NAMES AND FUNCTIONS	6-2
Exterior	6-2
Interior	6-3
Operation panel	6-4
Touch panel (Basic screen)	6-5
• USER MAINTENANCE	6-6
• TOUCH PANEL CONTRAST ADJUSTMENT	6-7
• SPECIFICATIONS	6-8

PART NAMES AND FUNCTIONS

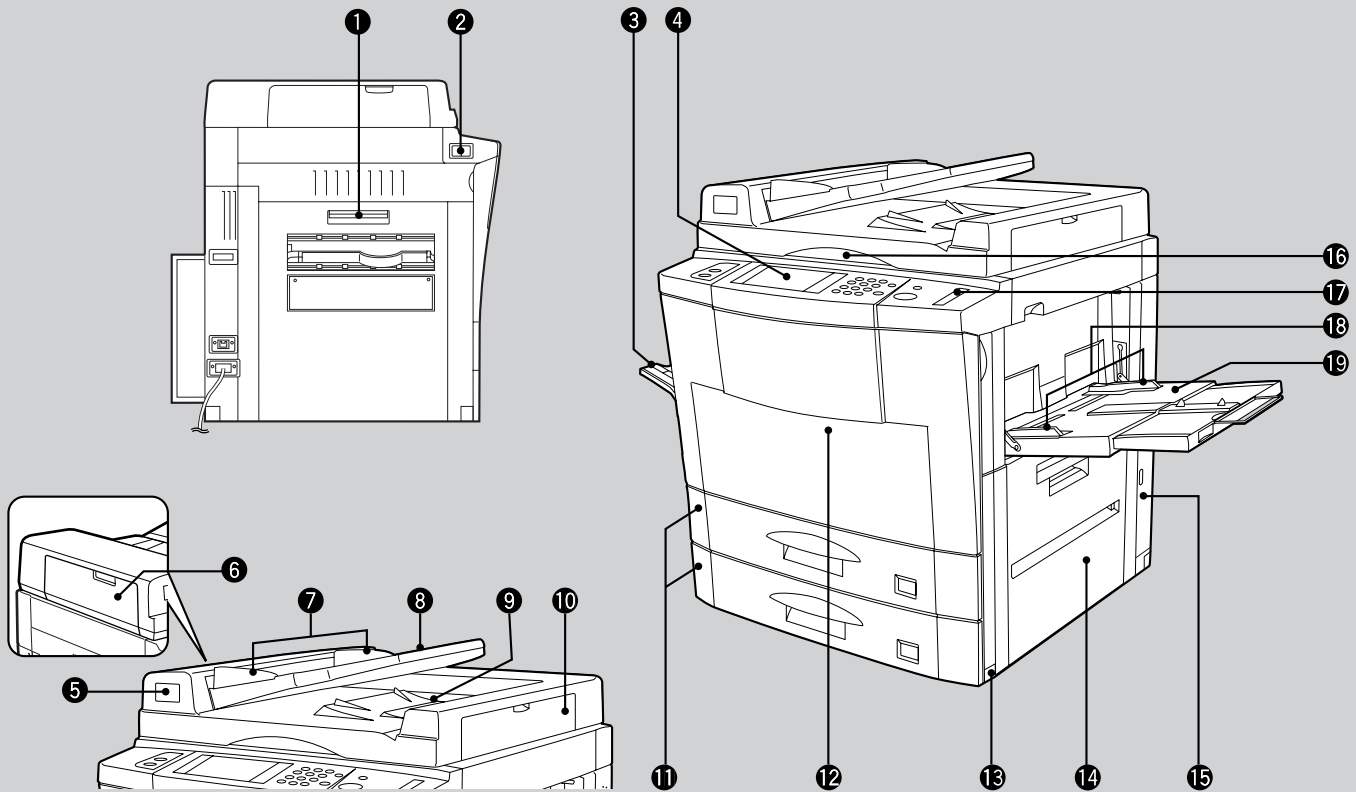
Exterior



- 1 Exit area cover**
Open to remove misfed paper.
- 2 Power switch**
Press to turn copier power on and off.
- 3 Exit tray (optional)**
Finished copies are deposited in the exit tray.
- 4 Operation panel**
All copier controls are located here for easy operation.
- 5 Document feeder indicators**
 -  Original feed indicator
Indicates the originals in the tray will be fed.
 -  Original reminder
Indicates an original is still on the document glass.
- 6 RADF feeding roller cover**
Open to remove misfed originals.
- 7 Original guides**
Adjust to the size of the originals.
- 8 Document feeder tray**
Holds up to 50 originals.
- 9 RADF exit area**
Finished originals are output here.
- 10 RADF exit roller cover**
Open to remove misfed originals.
- 11 Paper trays**
Each tray holds 500 sheets of 20 lb. bond paper.
- 12 Front cover**
Open to remove misfeeds and to service the copier.
- 13 Handles**
- 14 Right side cover**
Open to remove misfeeds in the paper feed area.
- 15 Toner collecting container cover**
Open to replace the toner collecting container.
- 16 Document glass**
All originals which cannot be copied from the RADF must be copied here.
- 17 Paper clip tray**
Keep paper clips here.

Interior

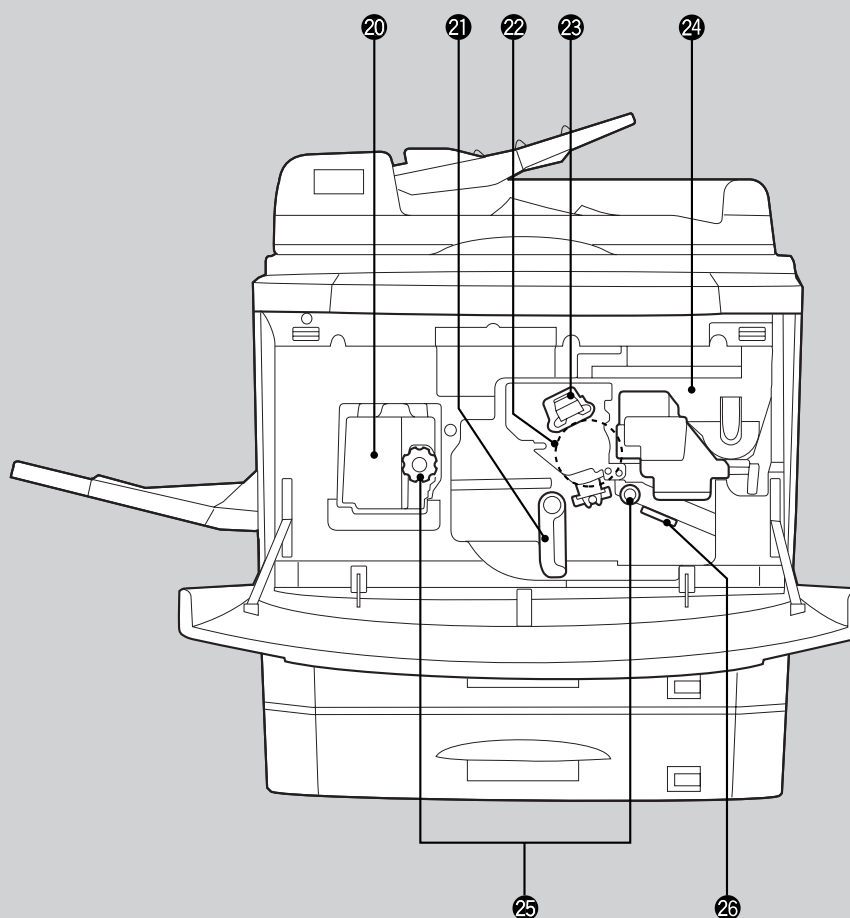

- 18 Bypass tray paper guides**
Adjust to the width of the copy paper.
- 19 Bypass tray**
Special papers (including transparency film) and copy paper can be fed from the bypass tray.
- 20 Fusing unit**
The fusing unit is hot. Exercise care in this area.
- 21 Transport lever**
Turn to open the transport section.
- 22 Photoconductive drum**
Copy images are formed on the photoconductive drum.
- 23 Corona unit**
The unit is used to charge the photoconductive drum.
- 24 Toner hopper**
Contains toner.
- 25 Roller rotating knobs**
Turn to remove misfed paper.
- 26 Paper guide**
Push down to remove misfed paper.

Accessories	
Operation manual	1
Key operator's guide	1
Toner collecting containers (including 1 pre-installed at the factory)	3

Operation Panel

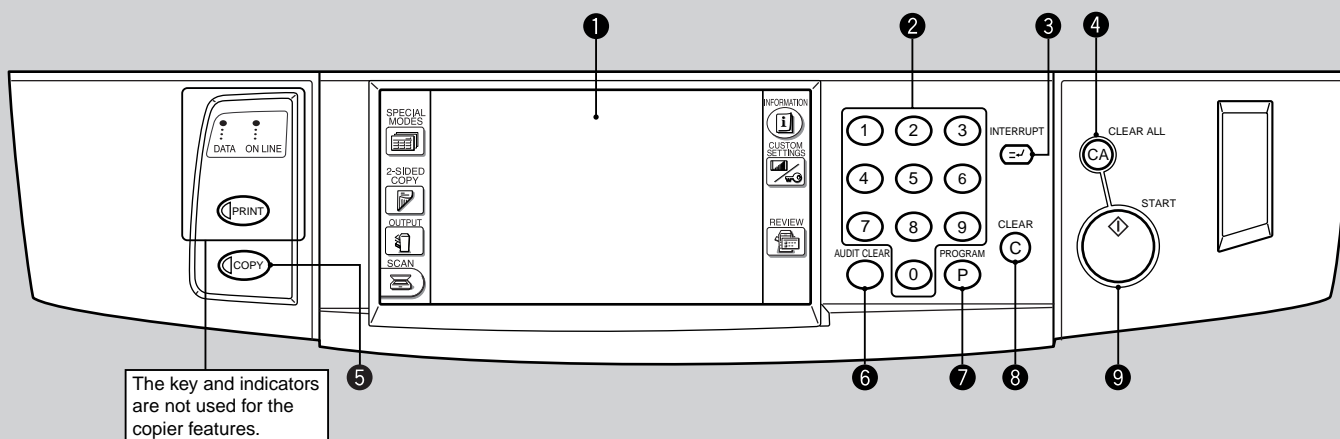

1 LCD touch panel

Displays information to assist the operator. Various operation keys are included in the touch panel depending on the particular screen being displayed.

2 10-key pad

Used to set the copy quantity.

3 INTERRUPT key and indicator (p. 2-20)

Interrupts a copy run.

4 CLEAR ALL (CA) key

Clears all selected settings and returns the copier to the initial settings.

5 COPY key

Press during standby to display the total output count.

6 AUDIT CLEAR key

Closes an open account.

7 PROGRAM (P) key (p. 2-18)

Press to select the job memory mode.

8 CLEAR (C) key

Press to clear the copy quantity display, or press during a copy run to terminate copying. The copier will stop after copies in progress are finished.

9 START key and indicator

Copying is possible when the indicator is on. Press to start copying.

10 SPECIAL MODES key (p.3-1)

Press to select special functions.

11 Message display

Messages are displayed regarding copier status and operation.

12 Function setting icons (p.1-9)

Icons appear depending on the special functions selected.

13 Paper size display

The sizes of loaded copy paper are displayed and the selected paper feed location is highlighted.  indicates the amount of copy paper.

14 Copy quantity display

Displays the specified number of copies.

15 Original size display

The original paper size is displayed.

16 INFORMATION key (p. 1-7)

Press for operation guidance on use of various features of this copier. Press for guidance when a misfeed occurs, when adding toner, or when used toner must be disposed of.

Touch Panel (Basic screen)

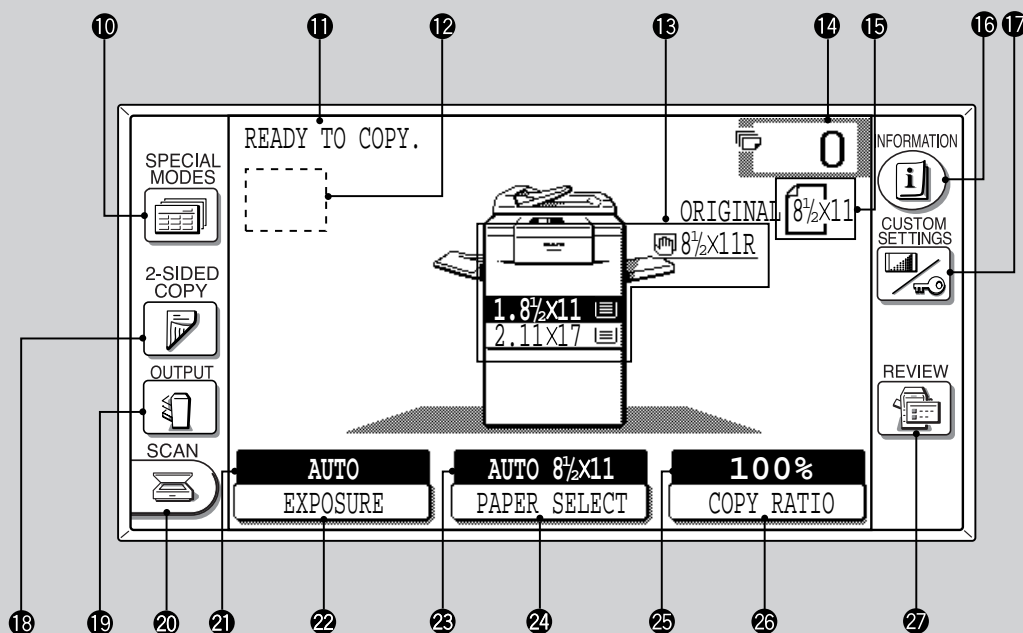

- 17 CUSTOM SETTINGS key**
Press to set key operator programs or adjust the contrast of the touch panel.
- 18 2-SIDED COPY key**
Press to select the 1-sided to 1-sided, 1-sided to 2-sided, 2-sided to 1-sided or 2-sided to 2-sided copy mode.
- 19 OUTPUT key**
Press to select the finisher mode: SORT or GROUP.
- 20 SCAN key**
Press to select the network scanner function. (Optional Printer Expansion Kit and Network Scanner Expansion Kit must be installed.)
- 21 EXPOSURE display**
Indicates the selected exposure mode.
- 22 EXPOSURE key** (p. 2-16)
Press to select the exposure mode: AUTO, TEXT, TEXT/PHOTO, or PHOTO.
- 24 PAPER SELECT display**
Displays the selected paper size. When "AUTO" is displayed, paper size matching the original and copy ratio will be automatically selected.
- 23 PAPER SELECT key**
Press to select the desired paper tray.
- 25 COPY RATIO display**
Displays the copy ratios for reductions or enlargements.
- 26 COPY RATIO key**
Press to select a reduction or enlargement copy ratio or select the automatic copy ratio selection mode.
- 27 REVIEW key**
Press to check the settings of selected functions.

Initial settings

The copier assumes the initial settings when the CLEAR ALL (CA) key is pressed and approximately 1 minute after the last copy is made in any mode. Except for the paper tray selection, the copier also assumes the initial setting when it is turned on.

- Copy ratio: 100%
- Automatic exposure
- Copy quantity: 0
- All special copier modes are set to off.
- Tray select: Paper tray 1 (At power on, the previously selected tray will again be selected.) Optional large capacity tray will be selected when installed.

★ **KEY OPERATOR** *Initial settings can be programmed as desired. The auto clear time can also be changed. See pages 17 and 21 of the KEY OPERATOR'S GUIDE.*

USER MAINTENANCE

The document glass and the document cover (RADF transport belt) must be kept clean to avoid dirty areas from being copied onto the copies.

Document glass and document cover

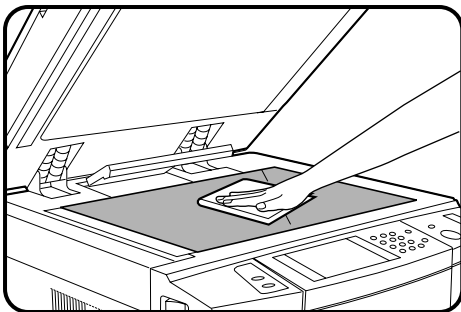

Wipe the document glass and the document cover (RADF transport belt) with a soft, clean cloth.

- If necessary, dampen the cloth with water. Do not use thinner, benzene, or similar volatile cleaning agents.

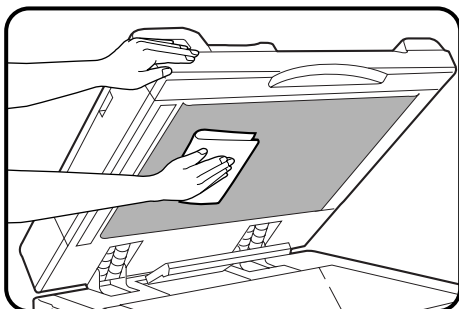

TOUCH PANEL CONTRAST ADJUSTMENT

The contrast of the touch panel can be adjusted as below.

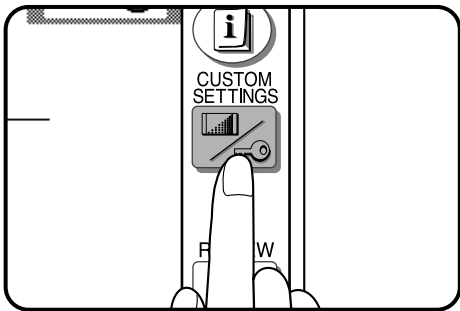

1 Press the **CUSTOM SETTINGS** key.

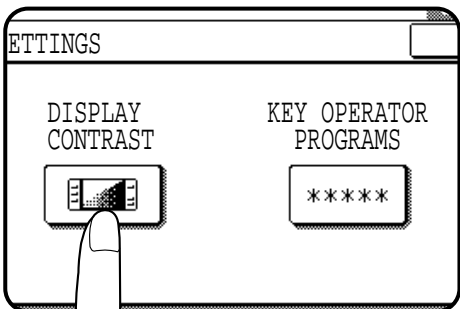

2 Press the **“DISPLAY CONTRAST”** key on the touch panel.

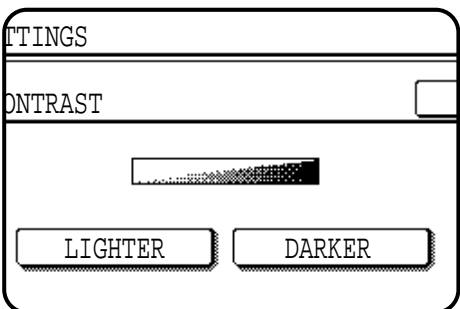

3 Press the **“LIGHTER”** or **“DARKER”** key to adjust the contrast.

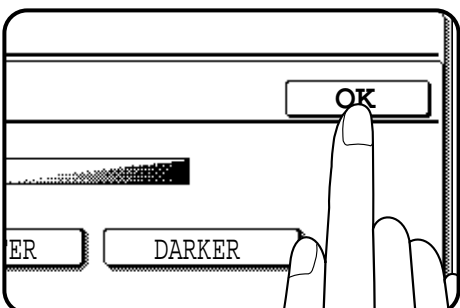

4 Press the **“OK”** key.

SPECIFICATIONS

COPIER

	AR-287	AR-337	AR-407
Type	Desktop		
Copy system	Dry, electrostatic transfer system		
Originals	Sheets, bound documents		
Original feed system	Reversing automatic document feeder (RADF)		
Original sizes	Max. 11" x 17"		
Copy sizes	Max. 11" x 17", min. 5-1/2" x 8-1/2" Image loss: Max. 13/64" (5 mm) (both leading and trailing edges) Max. 13/64" (5 mm) (along all other edges in total)		
Copying speed (at 100% copy ratio)	28 copies/min. (8-1/2" x 11") 20 copies/min. (8-1/2" x 11"R) 17 copies/min. (8-1/2" x 14") 14 copies/min. (11" x 17")	33 copies/min. (8-1/2" x 11") 24 copies/min. (8-1/2" x 11"R) 21 copies/min. (8-1/2" x 14") 17 copies/min. (11" x 17")	40 copies/min. (8-1/2" x 11") 27 copies/min. (8-1/2" x 11"R) 24 copies/min. (8-1/2" x 14") 19 copies/min. (11" x 17")
Continuous copy	Max. 999 copies; subtractive counter		
First-copy time*	Approx. 5.2 sec.		4.5 sec.
Warm-up time	Approx. 65 sec.		75 sec.
Copy ratio	Variable: 25 to 800% in 1% increments, total 776 steps		25 to 400% in 1% increments, total 376 steps
	(can be set in the horizontal and vertical directions independently) Fixed presets: 25%, 50%, 64%, 77%, 95%, 100%, 121%, 129%, 141%, 200%, 400% (800% for the AR-287 and AR-337 only)		
Exposure system	Document glass: Moving optical source (stationary platen) with automatic exposure function		
Copy paper feed	Two paper trays with automatic paper feed (500 sheets each); one bypass tray with 50-sheet automatic feed capability		
Fusing system	Heat rollers		
Developer system	Magnetic brush development		
Light source	Xenon lamp		
Resolution	Scan: 400 dpi Output: 600 dpi		
Gradation	Scan: 256 levels Output: 2 levels (normal copying)		
Required power supply	AC 120V, 60 Hz, 12 amperes		

* When the copier is in the noise level reduce mode, the first copy time will be several seconds longer.

	AR-287	AR-337	AR-407
Power consumption	Max. 1.44 kW		
Overall dimensions	50-7/8" (W) x 27-3/8" (D) (1292 mm (W) x 695 mm (D))		50-7/8" (W) x 27-9/16" (D) (1292 mm (W) x 700 mm (D))
Weight	Approx. 217 lbs. (98 kg)		
Copier dimensions	23-5/8" (W) x 27-3/8" (D) x 29-17/32" (H) (600 mm (W) x 695 mm (D) x 750 mm (H))		23-5/8" (W) x 27-9/16" (D) x 29-17/32" (H) (600 mm (W) x 700 mm (D) x 750 mm (H))
Operating conditions	Temperature: 59°F to 86°F (15°C to 30°C) Humidity: 20% to 85%		
Optional equipment	Finisher (AR-FN1N, AR-FN2) Large capacity tray (AR-LC1N) Stand/500-sheet paper drawer (AR-DE1N) 500-sheet paper drawer (AR-CS1) Dual tray output unit (AR-TR1) Exit tray (AR-TE1) Tandem - connection cable (AR-CA1) Printer expansion kit (AR-PB2A) Printer server card (AR-NC3D) Network scanner expansion kit (AR-NS1)		

DOCUMENT FEEDER

Type	Reversing automatic document feeder (RADF)
Acceptable originals	
Weight:	Single-sided originals: 14 to 34 lbs. Two-sided originals: 14 to 34 lbs. for 5-1/2" x 8-1/2" and 8-1/2" x 11" originals. 14 to 29 lbs. for 8-1/2" x 14" and 11" x 17" originals.
Size:	5-1/2" x 8-1/2" to 11" x 17"
Capacity:	Up to 50 sheets for 5-1/2" x 8-1/2" and 8-1/2" x 11" originals provided the total aggregate thickness does not exceed 1/4" or 6.5 mm (14 to 20 lbs.) or 3/16" or 5 mm (21 to 34 lbs.) Up to 30 sheets for 8-1/2" x 14" and 11" x 17" originals

DUPLEX MODULE

Paper type	Ordinary paper only
Number of copies	1 (trayless system)
Copy paper size	8-1/2" x 11", 8-1/2" x 11"R, 8-1/2" x 14", 11" x 17"
Copy paper weight	15 lbs. to 28 lbs.

Specifications are subject to change for improvement without notice.

CHAPTER 7

OPTIONAL EQUIPMENT

This chapter describes operating instructions for the Finisher (AR-FN1N, AR-FN2), Large Capacity Tray (AR-LC1N), Stand/500-sheet Paper Drawer (AR-DE1N) and Dual Tray Output Unit (AR-TR1).

	Page
• SYSTEM CONFIGURATION	7-2
• FINISHER (AR-FN1N)	7-3
Part names	7-3
Specifications	7-3
Offset stack	7-4
Sort and group	7-5
Staple sort	7-6
Staple cartridge replacement	7-10
Staple jam removal	7-12
Misfeed removal	7-14
• FINISHER (AR-FN2)	7-19
Part names	7-19
Specifications	7-19
Offset stack	7-20
Sort and group	7-21
Staple sort	7-22
Staple cartridge replacement	7-26
Staple jam removal	7-27
Misfeed removal	7-28
• LARGE CAPACITY TRAY (AR-LC1N)	7-30
Part names	7-30
Specifications	7-30
Loading copy paper	7-31
Misfeed removal	7-32
• STAND/500-SHEET PAPER DRAWER (AR-DE1N)	7-34
Part names	7-34
Specifications	7-34
Loading copy paper	7-35
Misfeed removal	7-36
• DUAL TRAY OUTPUT UNIT (AR-TR1)	7-37
Part names	7-37
Specifications	7-38

SYSTEM CONFIGURATION

The options which are available for this copier are shown below.

Finisher (AR-FN1N)

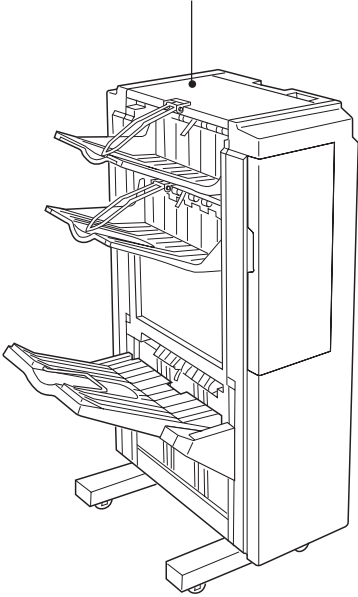

Finisher (AR-FN2)

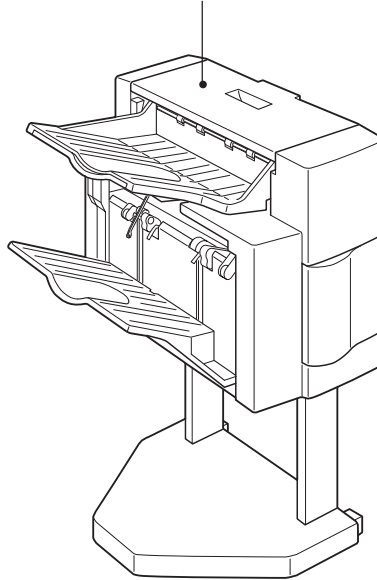

Large capacity tray (AR-LC1N)

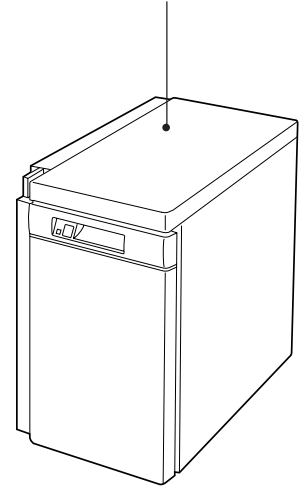

Dual tray output unit (AR-TR1)

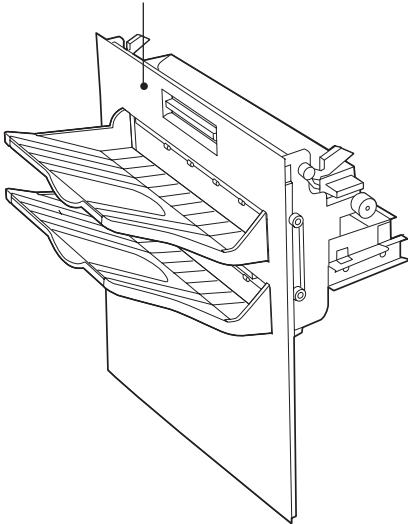

Exit tray (AR-TE1)

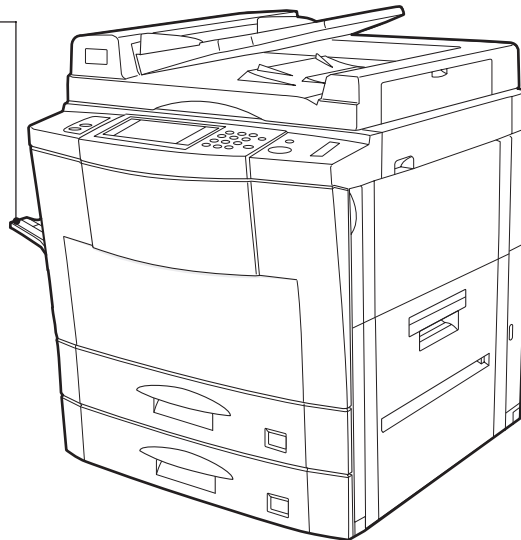

500-sheet paper drawer (AR-CS1)

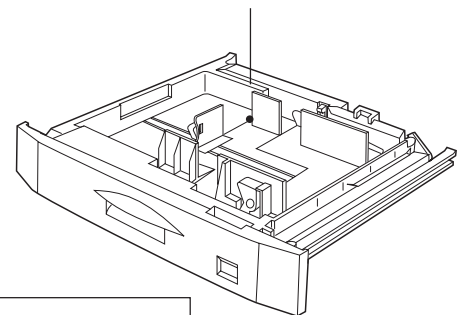

Stand/500-sheet paper drawer (AR-DE1N)

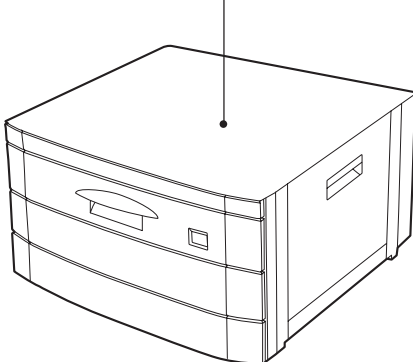

Printer expansion kit (AR-PB2A)
Printer server card (AR-NC3D)
Network scanner expansion kit (AR-NS1)
Tandem - connection cable (AR-CA1)

FINISHER (AR-FN1N)

The copier has two different finisher modes: one sorts copies into sets matching the sequence of the originals and the second groups copies by original. When the optional finisher (AR-FN1N) is installed, the copier can automatically staple the sorted copies. Each collated set of copies or group of copies can be stacked offset from the previous set.

PART NAMES

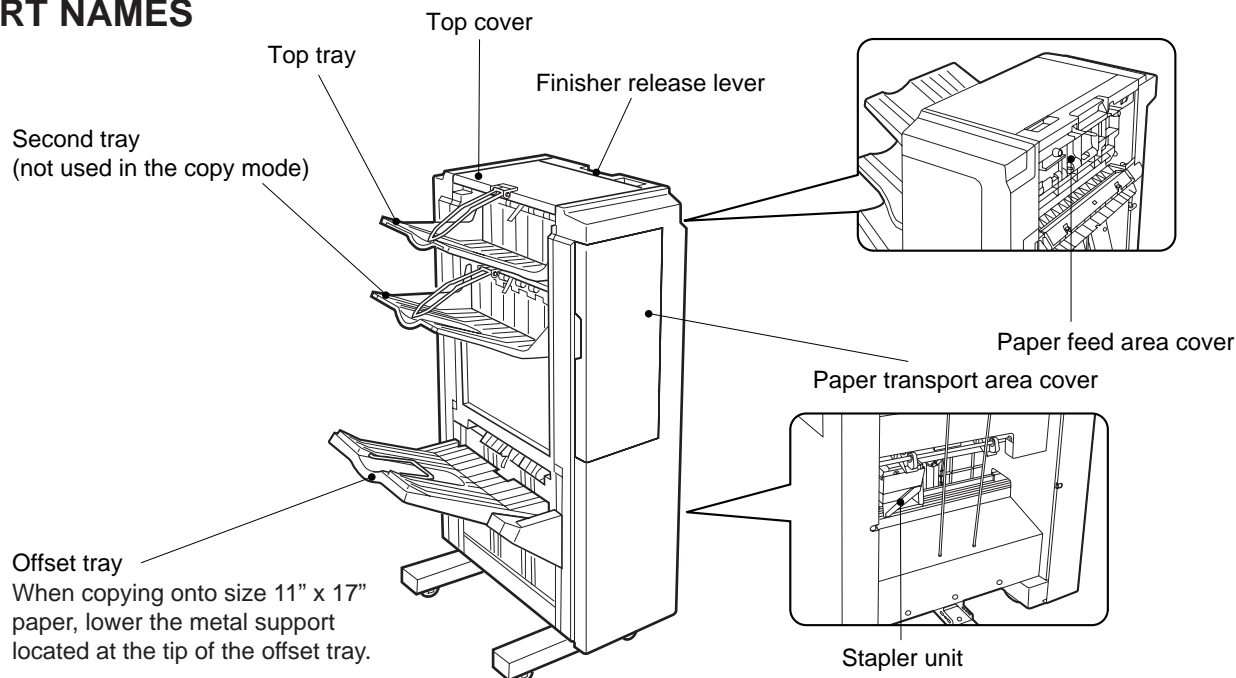

- The top tray and second tray are each furnished with an extendable component, which is to be used when copying onto size 11" x 17" paper.

Specifications

Tray capacity	Top tray: 500 sheets Second tray: 500 sheets Offset tray: 1,500 sheets (8-1/2" x 11") 750 sheets (larger than 8-1/2" x 11")
Paper size	Top tray: 5-1/2" x 8-1/2" to 11" x 17" Second tray: 5-1/2" x 8-1/2" to 11" x 17" Offset tray: 8-1/2" x 11" to 11" x 17"
Paper weight	Top tray: 14 lbs. to 34 lbs. (when face up) 17 lbs. to 28 lbs. (when face down) Second tray: 17 lbs. to 28 lbs. Offset tray: 17 lbs. to 34 lbs. (when face up) 17 lbs. to 28 lbs. (when face down) For paper weighing more than 28 lbs., 8-1/2" x 11" is the maximum size.
Offset	1.2 inch (30 mm)
Paper size for stapling	8-1/2" x 11", 8-1/2" x 11"R, 8-1/2" x 14", 11" x 17"
Stapling capacity	50 sheets (20 lbs.) (25 sheets for 8-1/2" x 14" and 11" x 17" paper)
Power supply	Drawn from the copier
Weight	Approx. 111 lbs. (50 kg)
Dimensions	23-15/64"(W) x 22-1/16"(D) x 39-19/64"(H) (590 mm (W) x 560 mm (D) x 998 mm (H))

Specifications are subject to change for improvement without notice.

Offset stack

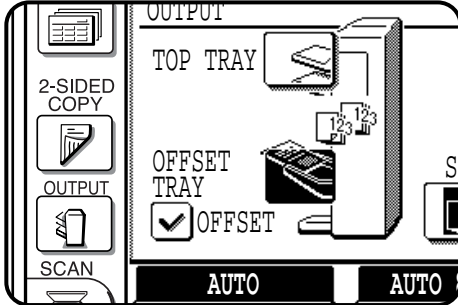

In the initial setting, the offset tray will move from side to side so that each copy set is offset by approximately 1.2 inch (30 mm).

When the offset stack function is disabled, the offset tray will not move from side to side.

The offset stack function can be enabled or disabled by pressing the OUTPUT key and then the "OFFSET" check mark box on the touch panel.

When the STAPLE SORT mode is selected, the offset stack function will be disabled.

The top tray cannot be used to offset copies.

To select the top tray, press the "TOP TRAY" key on the touch panel.

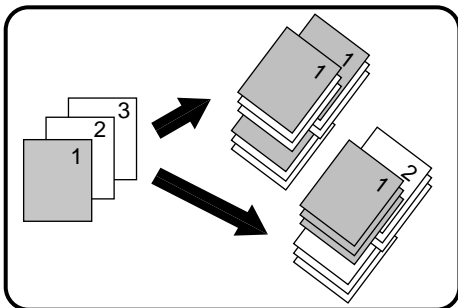

OFFSET mode

When copying in the SORT mode, each collated set of copies will be stacked offset approximately 1.2 inch (30 mm) from the previous set. When copying in the GROUP mode, copies will be offset stacked in groups of multiple copies from the same original.

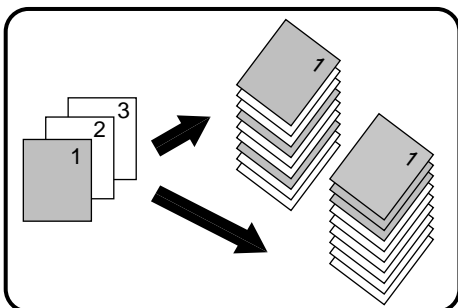

NON-OFFSET mode

All copies will be aligned in one stack in the offset tray or the top tray with no offset.

Sort and group

When SORT is selected, the SORT () icon will be indicated and copies will be collated by sets.

When STAPLE SORT is selected, the STAPLE SORT () icon will be indicated and collated copies will be stapled automatically.

When the SORT or STAPLE SORT icon is not indicated on the touch panel, copies will be grouped by originals.

To change the finisher mode, press the OUTPUT key and then select the desired mode on the touch panel.

- When the RADF is used for copying, copies will be collated in the OFFSET mode as the default setting.
When the document glass is used for copying, copies will be grouped in the OFFSET mode as the default setting.

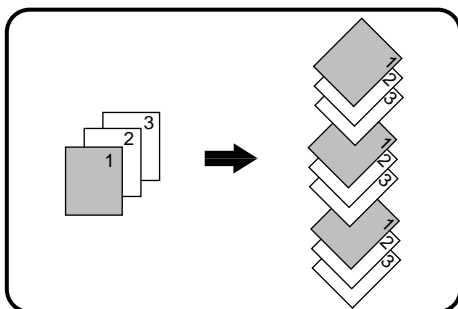

SORT mode

Each set of copies will be sequentially delivered to the offset tray or the top tray as selected.

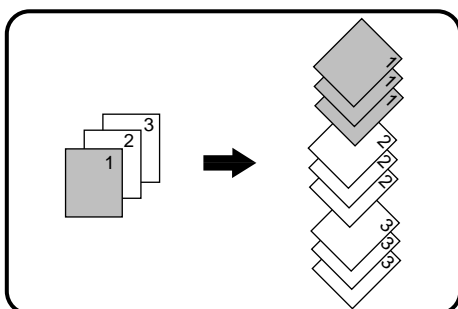

GROUP mode

All copies of the same original will be grouped in the offset tray or the top tray.

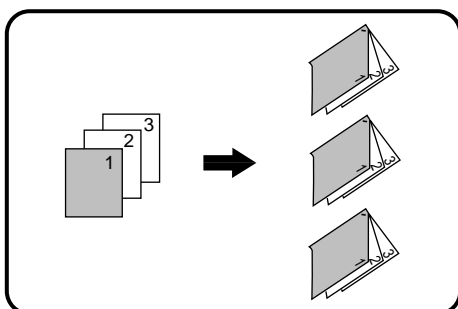

STAPLE SORT mode

Collated sets of copies will be stapled and delivered to the offset tray.

- See next page for details.

NOTE:

Rotation copy (image of original will be rotated when the orientation of the original does not match that of the copy paper) will not function when the STAPLE SORT mode is set.

Staple sort

The STAPLE SORT mode staples 8-1/2" x 11", 8-1/2" x 11"R, 8-1/2" x 14", and 11" x 17" size copies. Stapled sets cannot be delivered to the top tray.

NOTE:

Different size originals cannot be copied onto copy paper of their respective sizes in the STAPLE SORT mode. The paper size selected for the first scanned original will be used for all originals. To copy different size originals in the STAPLE SORT mode, select the paper size for the largest original.

Using the RADF

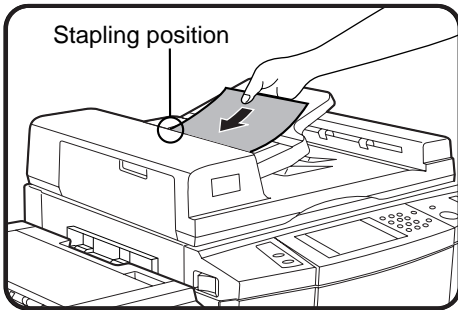

1 Set the originals in the document feeder tray.

- If the number of copies in one set is more than 50 for 8-1/2" x 11" or 8-1/2" x 11"R paper or 25 for 8-1/2" x 14" or 11" x 17" paper, the copies will not be stapled.
- The stapling position shown in the left figure is the factory default position.

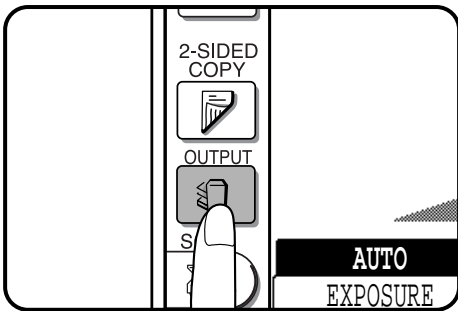

2 Press the OUTPUT key.

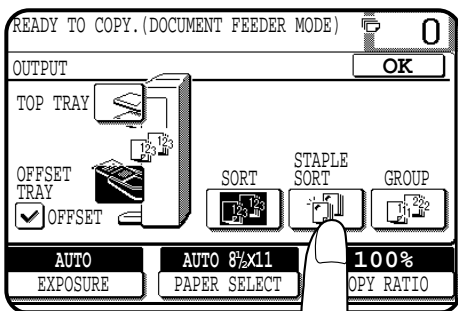

3 Press the "STAPLE SORT" key on the touch panel.

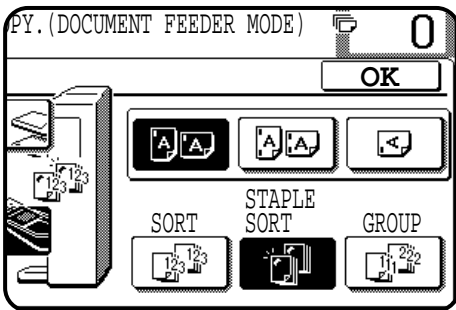

4 Select the desired stapling position.

- The AR-FN1N finisher has three selectable stapling positions as shown below.

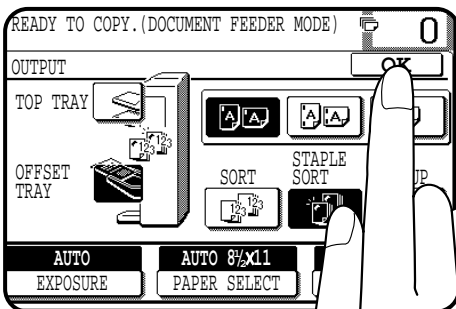
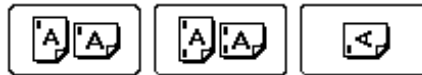

5 Press the “OK” key.

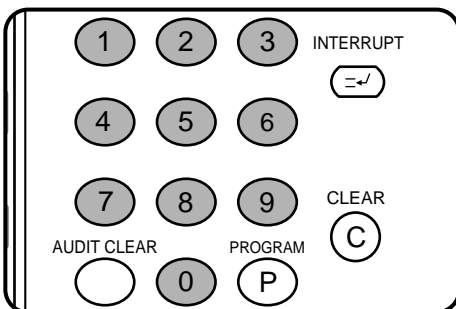

6 Set the number of copies.

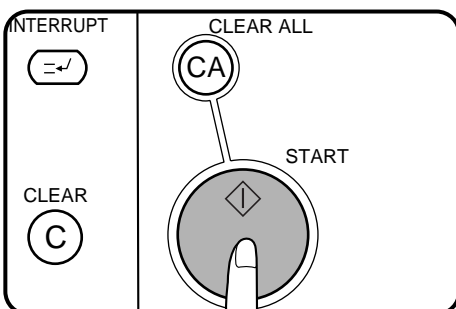

7 Press the **START** key.

- When copying of one set is completed, the copies will be automatically stapled and delivered to the offset tray.

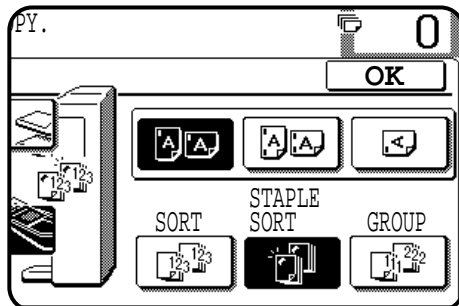
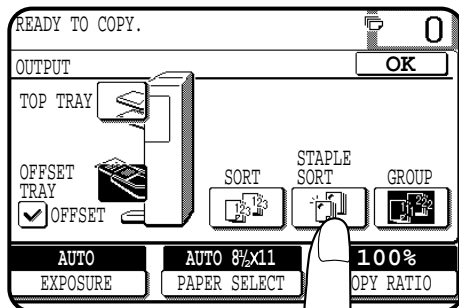
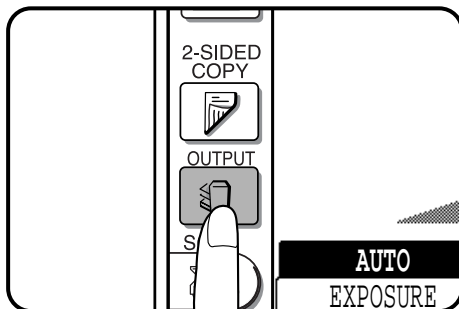
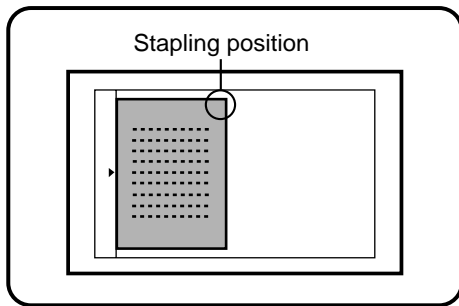

Using the document glass

1 Set the original on the document glass with the corner to be stapled to the upper right.

- Copy from the last page to the first page.
- If the number of copies in one set is more than 50 for 8-1/2" x 11" or 8-1/2" x 11"R paper or 25 for 8-1/2" x 14" or 11" x 17" paper, the copies will not be stapled.
- The stapling position shown in the left figure is the factory default position.

2 Press the OUTPUT key.

3 Press the "STAPLE SORT" key on the touch panel.

4 Select the desired stapling position.

- The AR-FN1N finisher has three selectable stapling positions as shown below.

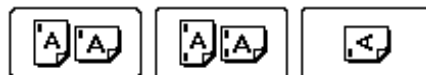

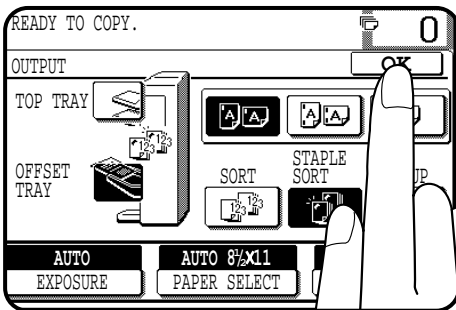

5 Press the “OK” key.

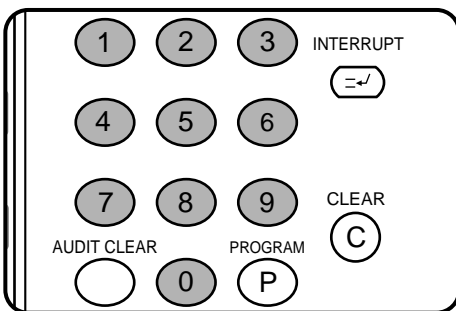

6 Set the number of copies.

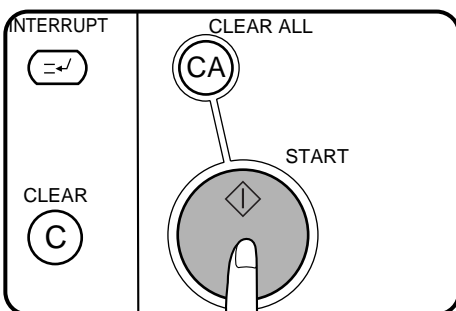

7 Press the START key.

8 Remove the finished original with the next original after the START key indicator lights up, and then press the START key. Repeat this step until all originals have been scanned.

- Up to 120 sheets of 8-1/2" x 11" originals or up to 60 sheets of originals larger than 8-1/2" x 11" can be scanned.

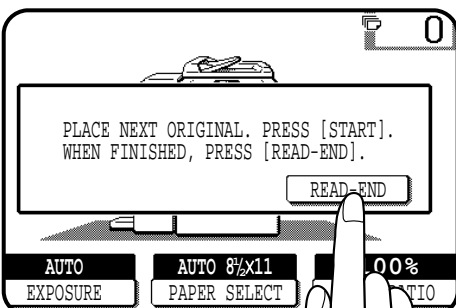

9 After all originals are scanned, press the “READ-END” key on the touch panel.

- Copying will start and each set of copies will be automatically stapled and delivered to the offset tray.

Staple cartridge replacement

The message "SLIDE THE FINISHER AWAY FROM THE COPIER AND ADD STAPLES." will appear when the staple cartridge is empty. Replace the staple cartridge as follows:

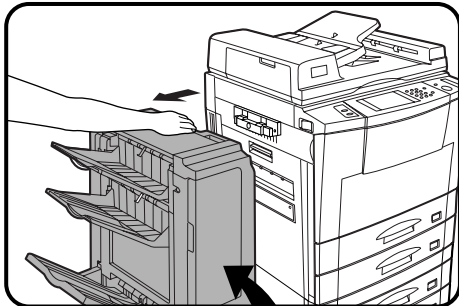

- 1** While holding the finisher release lever, slide the finisher away from the copier.

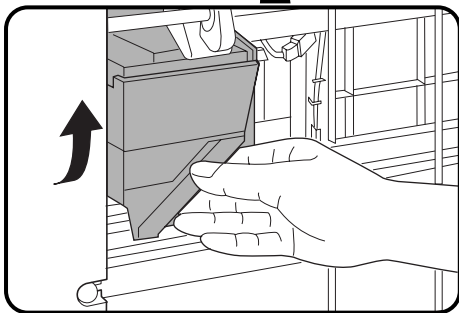

- 2** Turn the stapler unit to face up.

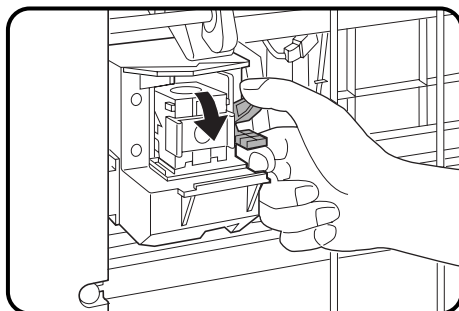

- 3** Hold the staple box release lever to unlatch the staple box.

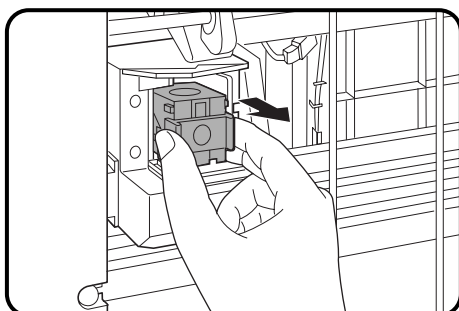

- 4** Remove the staple box.

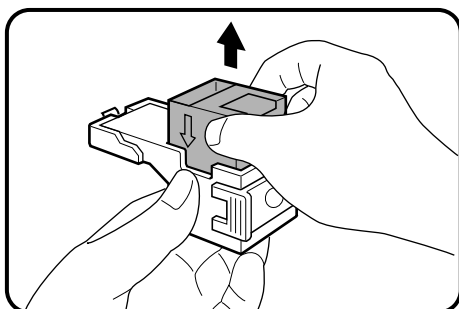

- 5** Remove the empty staple cartridge from inside the staple box.

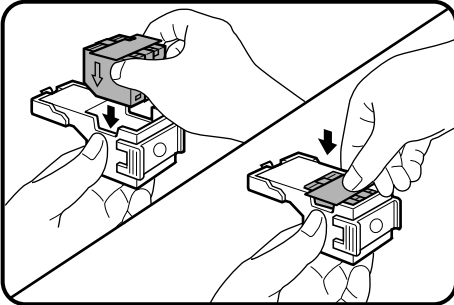

6 Insert the new staple cartridge into the box until it clicks in place.

- Insert the new cartridge by aligning the arrows on the cartridge with those on the box. Check that the cartridge locks in place by pulling it slightly.
- The cartridge holds 5,000 staples.

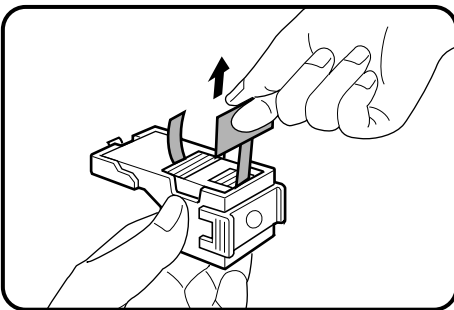

7 Remove the rear paper and tape from the cartridge.

- Pull them straight. If they are pulled obliquely, the tape may be torn.

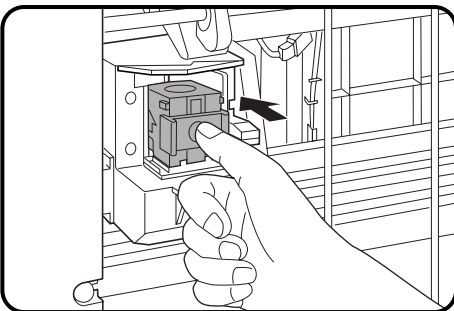

8 Insert the staple box to the stapler unit until it clicks into place.

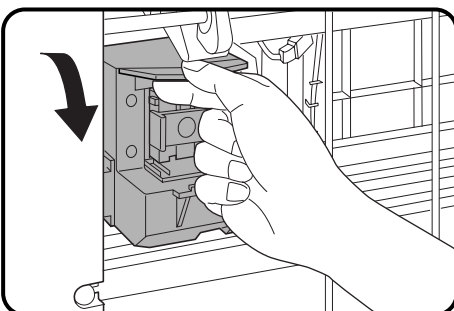

9 Return the stapler unit to face down.

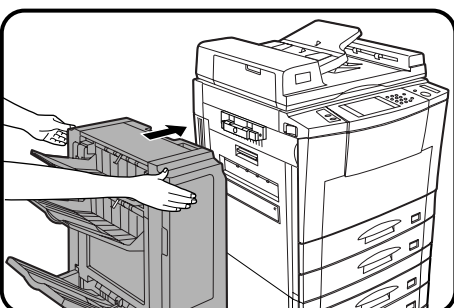

10 Push the finisher toward the copier and latch it in place.

Staple jam removal

If staples become jammed in the stapler, "CHECK STAPLER POSITION OR STAPLE JAM." will be displayed. Remove the jammed staples in the manner described below.

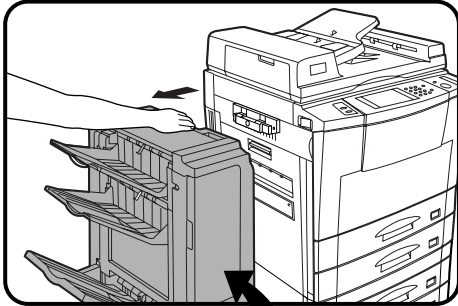

1 While holding the finisher release lever, slide the finisher away from the copier.

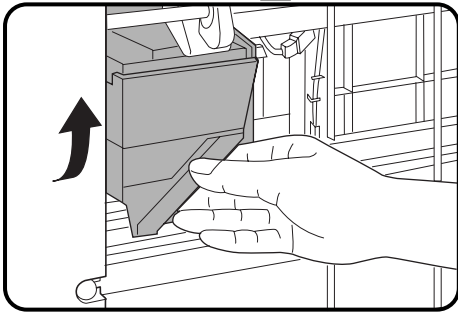

2 Turn the stapler unit to face up.

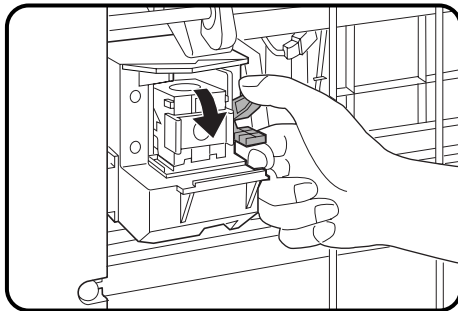

3 Hold the staple box release lever to unlatch the staple box.

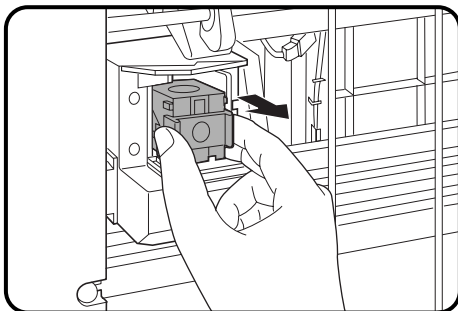

4 Remove the staple box.

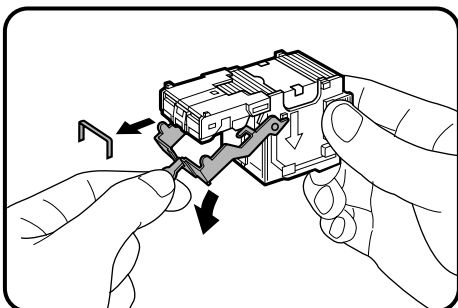

5 Lower the lever at the end of the staple box and remove the jammed staples.

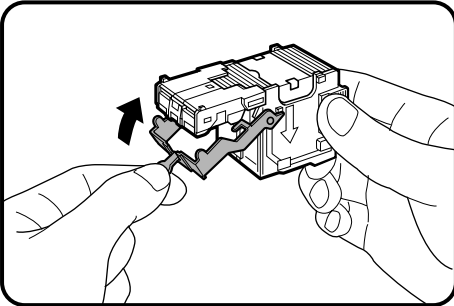

6 Return the lever to its original position.

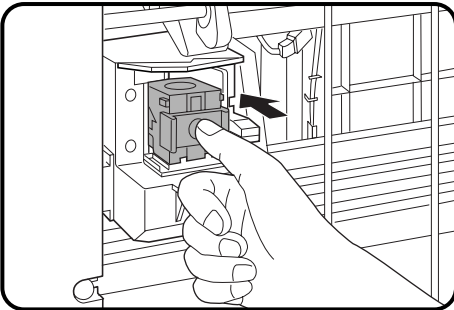

7 Insert the staple box to the stapler unit until it clicks in place.

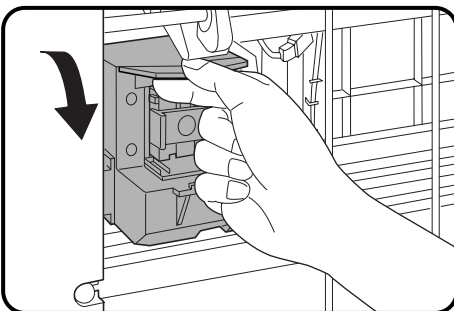

8 Return the stapler unit to face down.

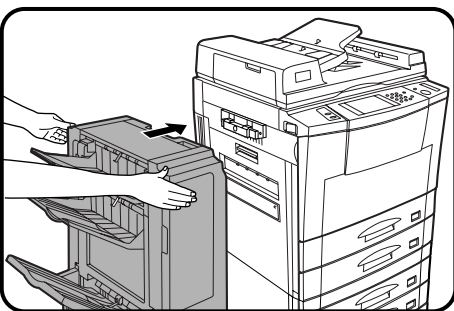

9 Push the finisher toward the copier and latch it in place.

Misfeed removal

The copier will stop when a misfeed occurs.

The message "A MISFEED HAS OCCURRED. CLEAR INDICATED AREA. PRESS **i** FOR RECOVERY INSTRUCTIONS." will appear with a display of paper misfeed locations. Press the INFORMATION key for more detailed information as necessary.

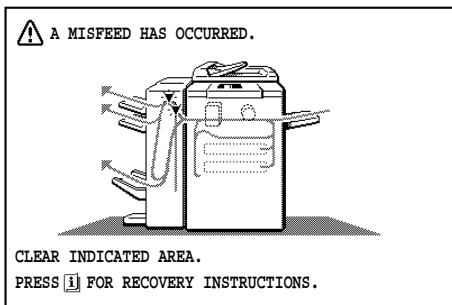

Misfeed in the upper transport area

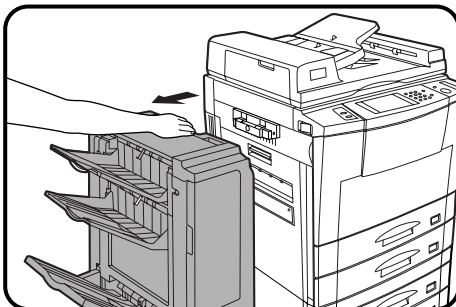

- 1 While holding the finisher release lever, slide the finisher away from the copier.

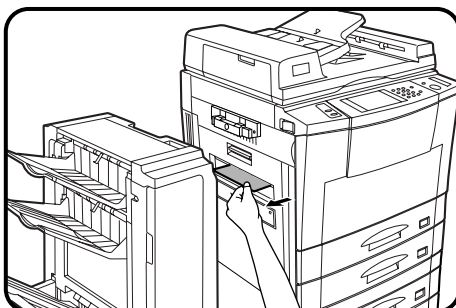

- 2 Remove the misfed paper.

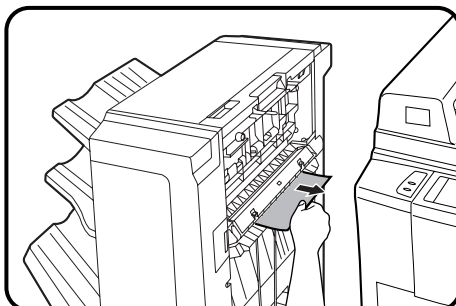

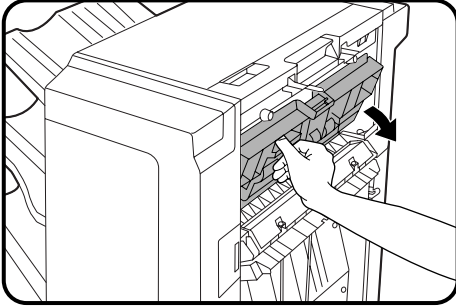

3 If the misfed paper cannot be removed in step 2, open the cover of the paper feed area of the finisher.

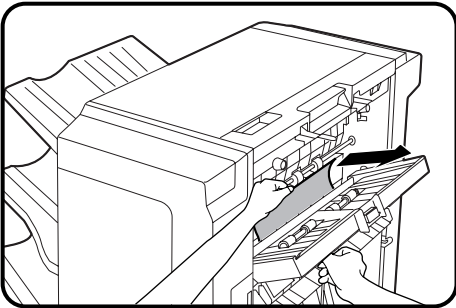

4 Remove the misfed paper.

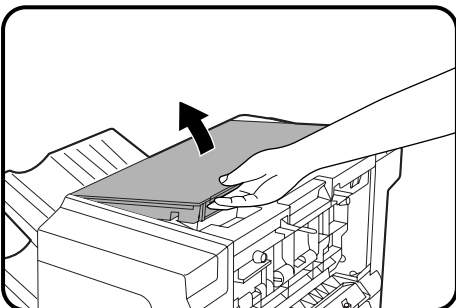

5 If the misfed paper cannot be removed in step 4, close the cover of the paper feed area and open the top cover.

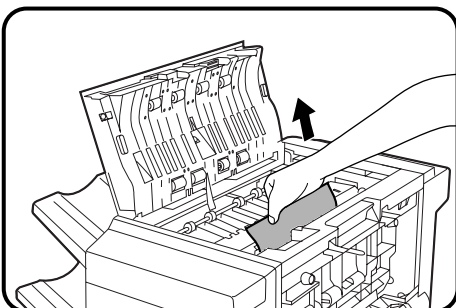

6 Remove the misfed paper.

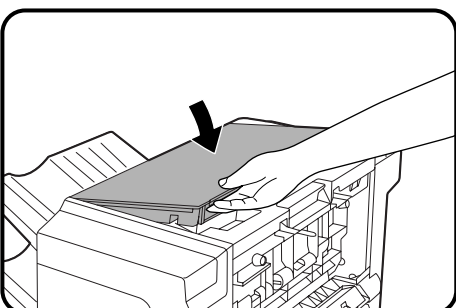

7 Close the top cover.

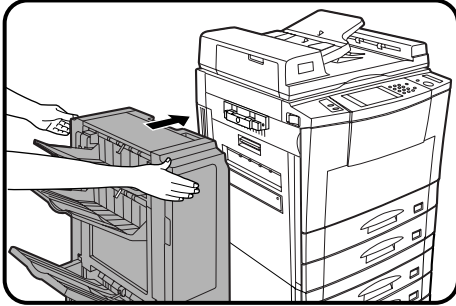

- 8** Push the finisher toward the copier and latch it in place.
- Confirm that the misfeed display is cleared.

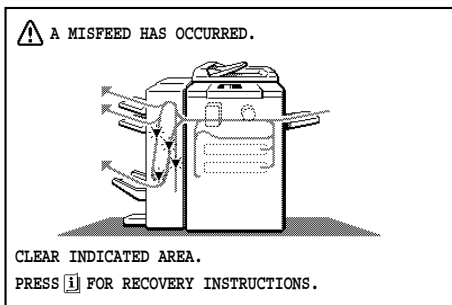

Misfeed in the lower transport area

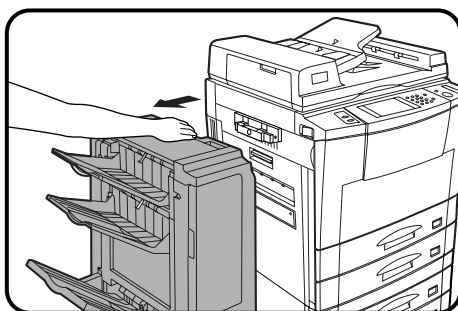

- 1** While holding the finisher release lever, slide the finisher away from the copier.

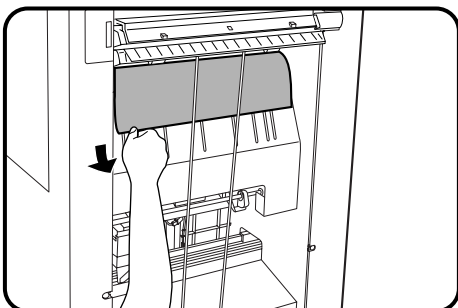

- 2** Remove the misfed paper from the paper transport area as shown in the illustration.

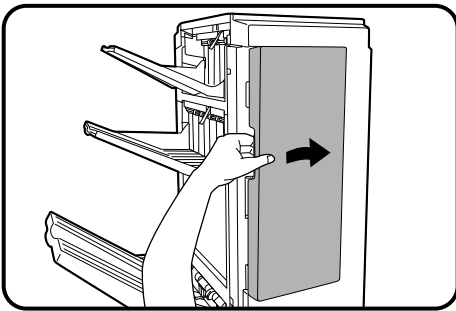

3 Open the paper transport area cover of the finisher.

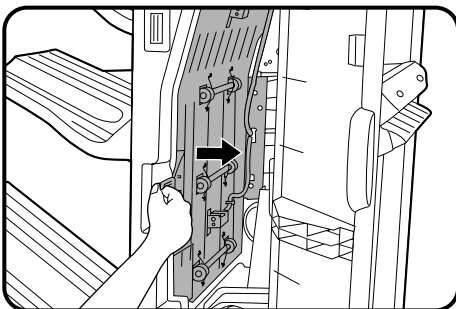

4 Use the transport area lever to open the transport.

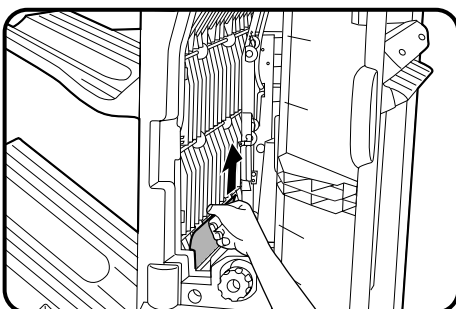

5 Remove the misfed paper.

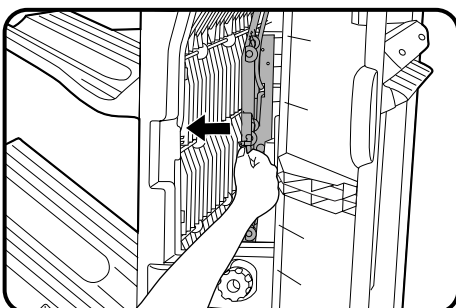

6 Close the transport.

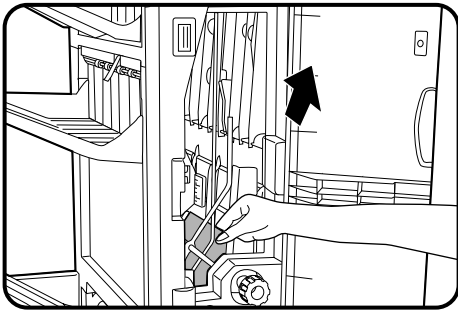

7 Remove the misfed paper.

- Remove the misfed paper from the paper transport area.

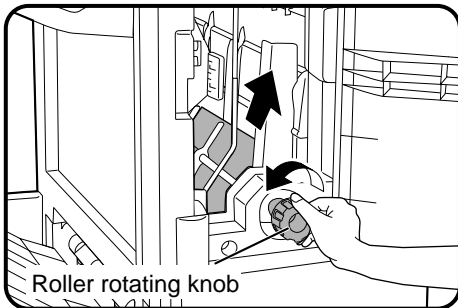

- If the misfed paper is not seen in the paper transport area, turn the roller rotating knob to feed the paper.

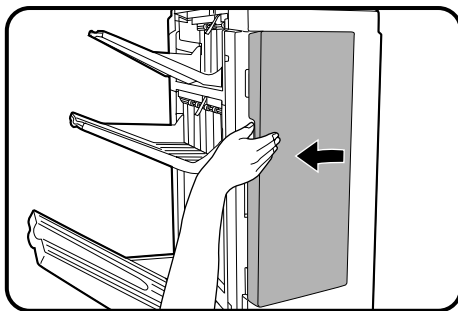

8 Close the paper transport area cover.

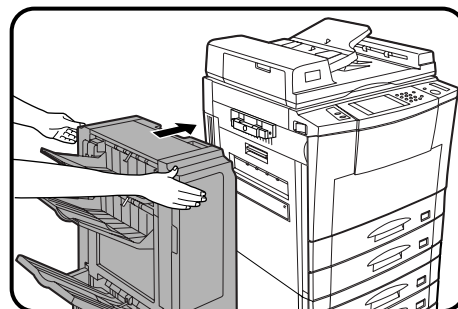

9 Push the finisher toward the copier and latch it in place.

- Confirm that the misfeed display is cleared.

FINISHER (AR-FN2)

The copier has two different finisher modes: one sorts copies into sets matching the sequence of the originals and the second groups copies by original. When an optional finisher (AR-FN2) is installed, the copier can automatically staple the sorted copies. Each collated set of copies or group of copies can be stacked offset from the previous set.

PART NAMES

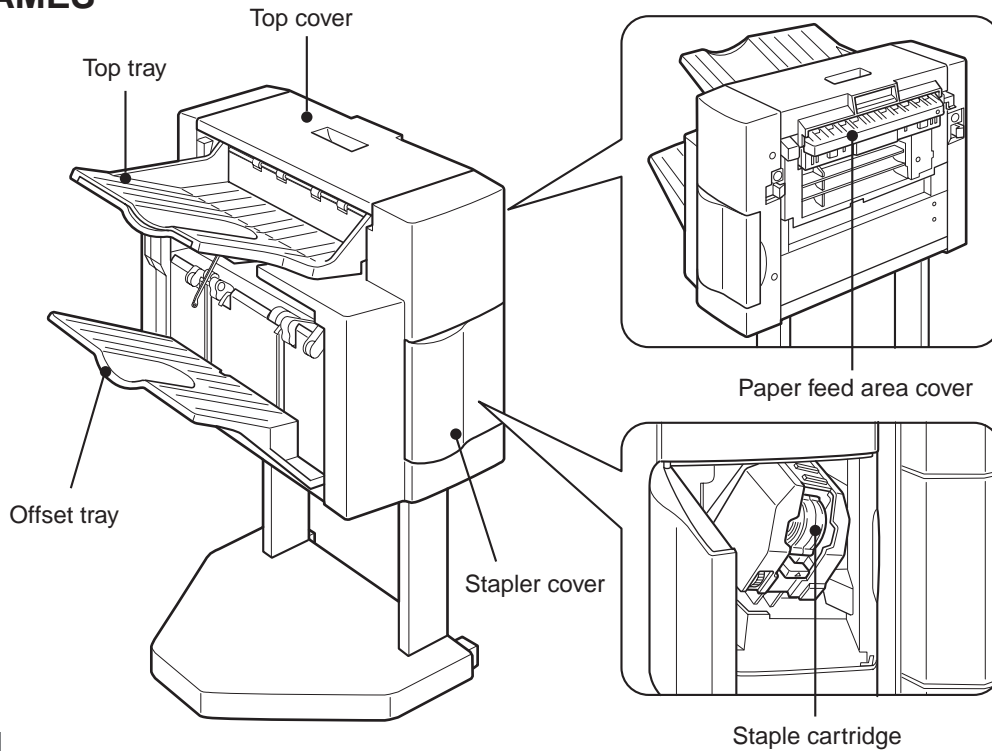

CAUTION

Do not put pressure on the finisher or subject it to undue force.

Specifications

Tray capacity	Top tray: 250 sheets Offset tray: 750 sheets
Paper size	Top tray: 5-1/2" x 8-1/2" to 11" x 17", 12" x 18" Offset tray: 8-1/2" x 11"
Paper weight	Top tray: 14 lbs. to 34 lbs. Offset tray: 15 lbs. to 34 lbs. For paper weighing more than 28 lbs., 8-1/2" x 11" is the maximum size.
Offset	Min. 61/64 inch
Paper size for stapling	8-1/2" x 11"
Stapling capacity	30 sheets (20 lbs.)
Power supply	Drawn from the copier
Weight	Approx. 49 lbs. (22 kg)
Dimensions	18"(W) x 20-13/32"(D) x 32-19/64"(H) (457 mm (W) x 518 mm (D) x 820 mm (H))

Specifications are subject to change for improvement without notice.

Offset stack

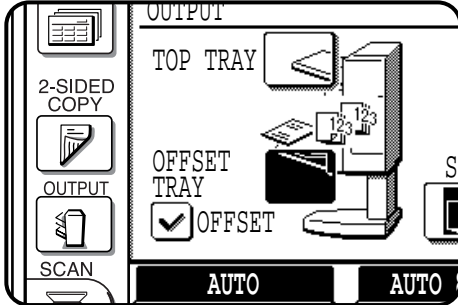

In the initial setting, the top tray is selected.

To select the offset tray, press the OUTPUT key and then the "OFFSET TRAY" key on the touch panel.

If the offset tray is selected, each copy set will be offset by a minimum of 61/64 inch.

When the offset stack function is disabled, copies will not be offset.

The offset stack function can be enabled or disabled by pressing the "OFFSET" check mark box on the touch panel.

When the STAPLE SORT mode is selected, the offset stack function will be disabled.

If the offset tray is selected, only 8-1/2" x 11" paper can be used.

The top tray cannot be used to offset copies.

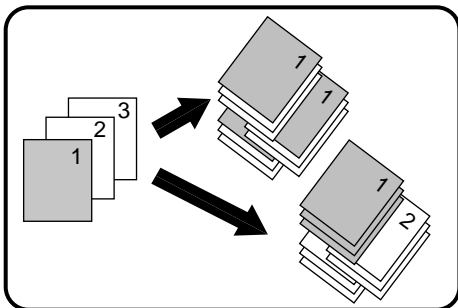

OFFSET mode

When copying in the SORT mode, each collated set of copies will be stacked offset a minimum of 61/64 inch from the previous set. When copying in the GROUP mode, copies will be offset and stacked in groups of multiple copies from the same original.

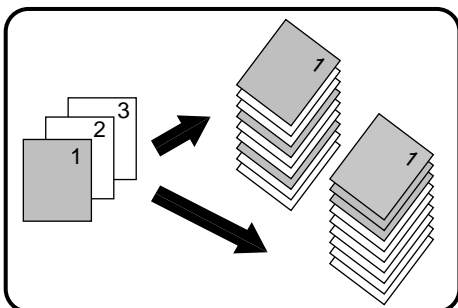

NON-OFFSET mode

All copies will be aligned in one stack in the offset tray or the top tray with no offset.

Sort and group

When SORT is selected, the SORT () icon will be indicated and copies will be collated by sets.

When STAPLE SORT is selected, the STAPLE SORT () icon will be indicated and collated copies will be stapled automatically.

When the SORT or STAPLE SORT icon is not indicated on the touch panel, copies will be grouped by originals.

To change the finisher mode, press the OUTPUT key and then select the desired mode on the touch panel.

- When the RADF is used for copying, copies will be collated at the default setting.
When the document glass is used for copying, copies will be grouped at the default setting.
- In the STAPLE SORT mode, only 8-1/2" x 11" paper can be used.

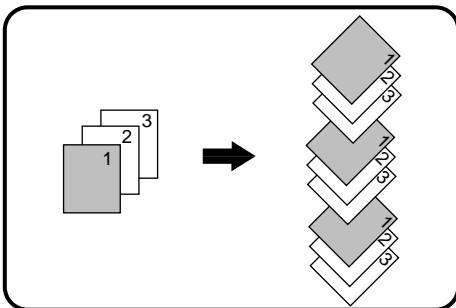

SORT mode

Each set of copies will be sequentially delivered to the offset tray or the top tray as selected.

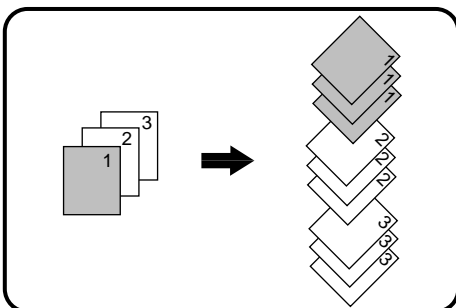

GROUP mode

All copies of the same original will be grouped in the offset tray or the top tray.

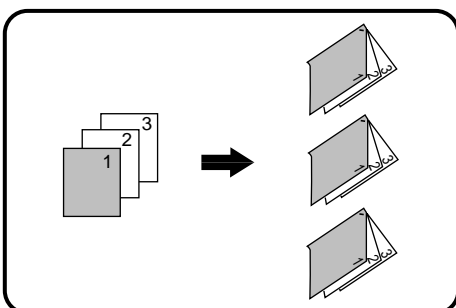

STAPLE SORT mode

Collated sets of copies will be stapled and delivered to the offset tray.

- See next page for details.

Staple sort

The STAPLE SORT mode staples 8-1/2" x 11" size copies. Stapled sets cannot be delivered to the top tray.

NOTE:

Different size originals cannot be copied onto copy paper of their respective sizes in the STAPLE SORT mode. Only 8-1/2" x 11" size paper can be selected in the STAPLE SORT mode.

Using the RADF

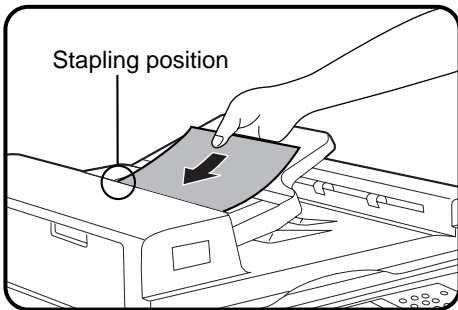

1 Set the originals in the document feeder tray.

- If the number of copies in one set is more than 30, the copies will not be stapled.
- If the orientation of the originals does not match that of the copy paper, the images of the originals will be rotated. The stapling position in this case is shown below.

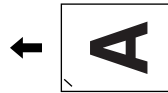

- If originals in the landscape orientation are copied, the copies will be stapled at an improper position.



2 Press the OUTPUT key.

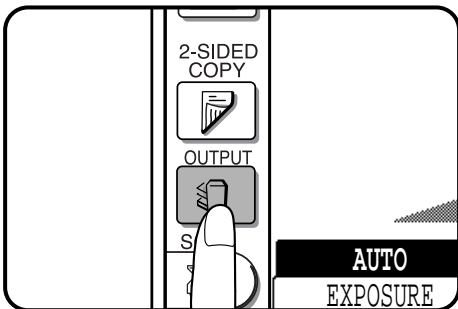

3 Press the "STAPLE SORT" key on the touch panel.

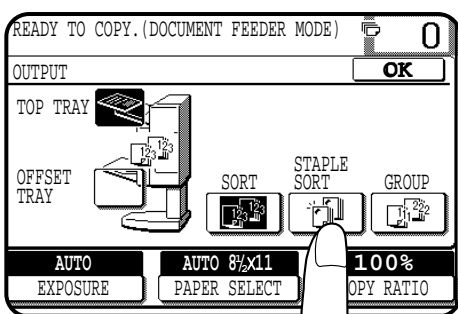

OPTIONAL EQUIPMENT
Finisher (AR-FN2)

CHAPTER 7

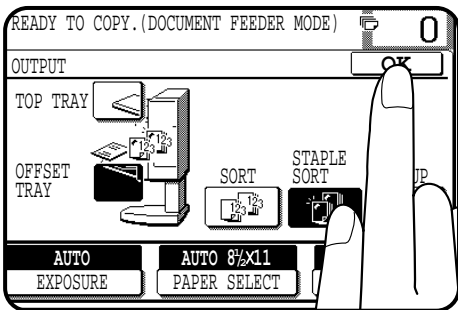

4 Press the “OK” key.

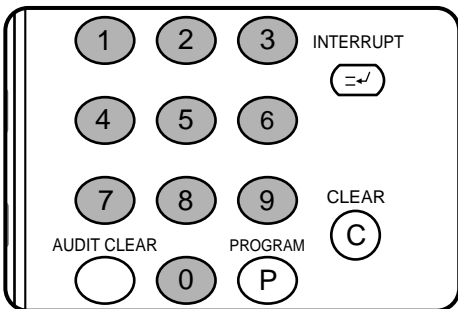

5 Set the number of copies.

- If 8-1/2" x 11" paper has not been selected, press the “PAPER SELECT” key and select a paper tray containing 8-1/2" x 11" paper.

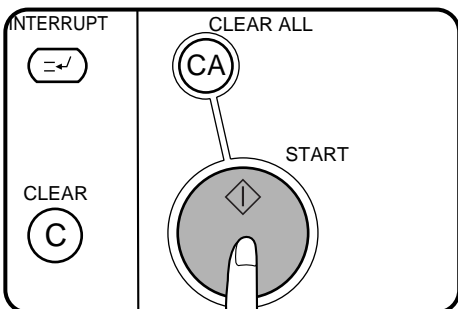

6 Press the **START** key.

- When copying of one set is completed, the copies will be automatically stapled and delivered to the offset tray.

Using the document glass

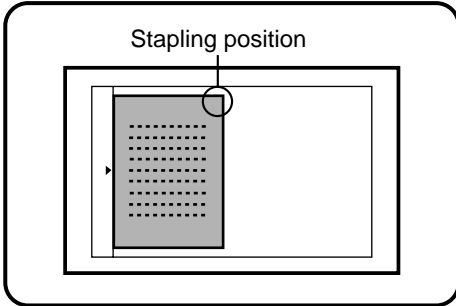

1 Set the original on the document glass with the corner to be stapled to the upper right.

- Copy from the last page to the first page.
- If the number of copies in one set is more than 30, the copies will not be stapled.
- If the orientation of the original does not match that of the copy paper, the image of the original will be rotated. The stapling position in this case is shown below.



- If originals in the landscape orientation are copied, the copies will be stapled at an improper position.

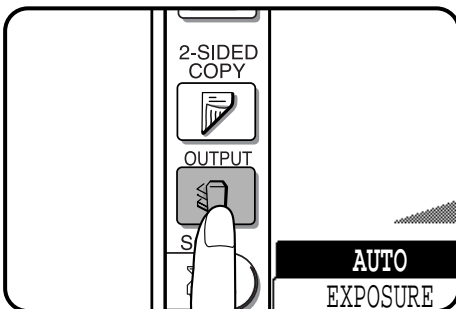

2 Press the OUTPUT key.

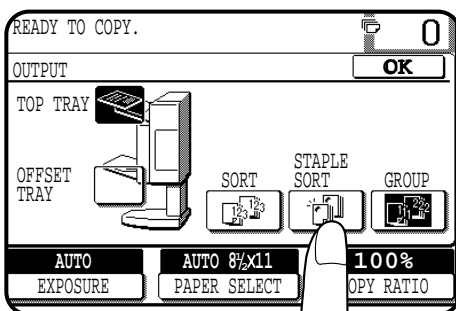

3 Press the "STAPLE SORT" key on the touch panel.

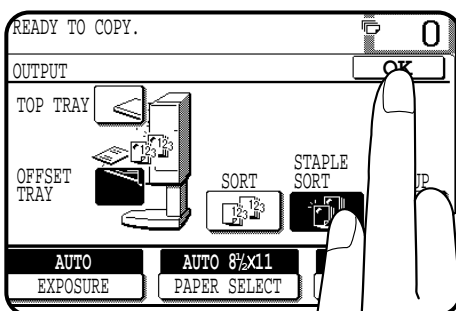

4 Press the "OK" key.

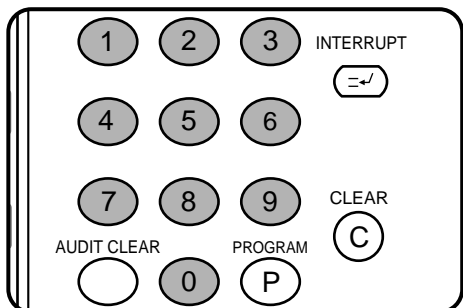

5 Set the number of copies.

- If 8-1/2" x 11" paper is not selected, press the "PAPER SELECT" key and select a paper tray containing 8-1/2" x 11" paper.

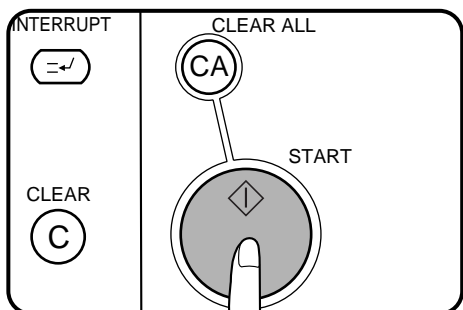

6 Press the START key.

- 7** Replace the finished original with the next original after the START key indicator lights up, and then press the START key. Repeat this step until all originals have been scanned.

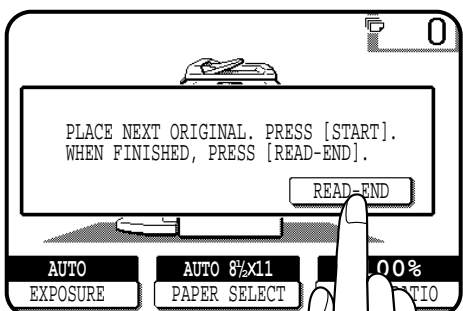

8 After all originals are scanned, press the "READ-END" key on the touch panel.

- Copying will start and each set of copies will be automatically stapled and delivered to the offset tray.

Staple cartridge replacement

The message "ADD STAPLES." will appear when the staple cartridge is empty. Replace the staple cartridge as follows:

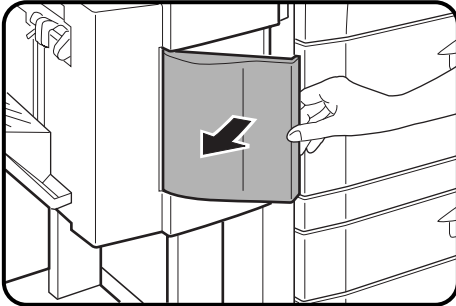

1 Open the stapler cover.

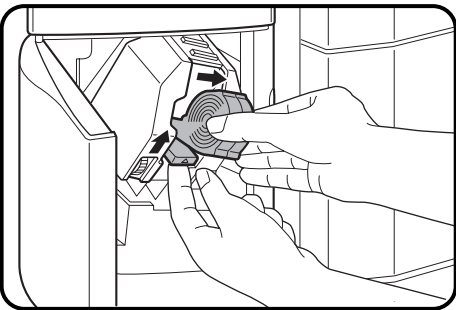

2 Lift the green release lever and remove the staple cartridge from the stapler.

- A few staples will be left in the cartridge. Remove and discard them.

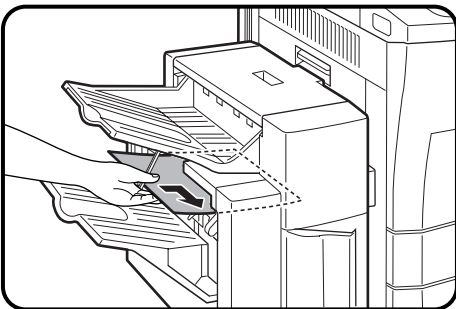

3 Insert a new sheet of paper (8-1/2" x 11" or A4 size) to the tray as shown in the picture to make the stapler work properly.

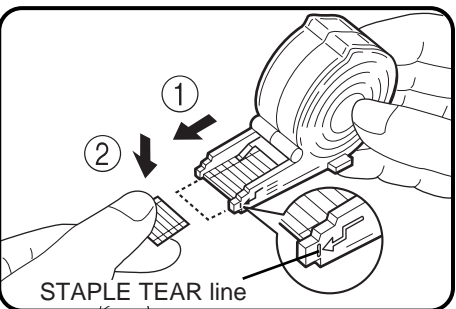

4 Check that the first staple in the new cartridge is at the tip of the cartridge.

- If the first staple is not at the tip, pull it to the tip. If any staples are protruding past the cartridge tip, tear them off at the STAPLE TEAR line and align the first staple with the tip.
- A cartridge holds 5,000 staples.

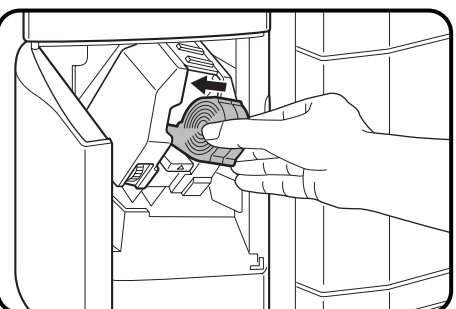

5 Push the new staple cartridge in until it clicks in place.

6 Close the stapler cover.

- The stapler will strike three times without stapling and feed staples automatically.
- Remove the paper from the tray.
- To check that the stapler works properly, copy an original and staple it.

Staple jam removal

The message “**CHECK STAPLER POSITION OR STAPLE JAM**” will appear either when the staple cartridge is empty or when there is a staple jam. Please proceed as follows. Open the stapler cover and remove the staple cartridge by lifting the green release lever.

- If the cartridge is empty (a few staples might remain in the cartridge), refer to the section entitled “Staple Cartridge Replacement” on page 7-26.
- If there are sufficient staples left in the cartridge, the stapler is jammed. Remove the jammed staples in the manner described below.

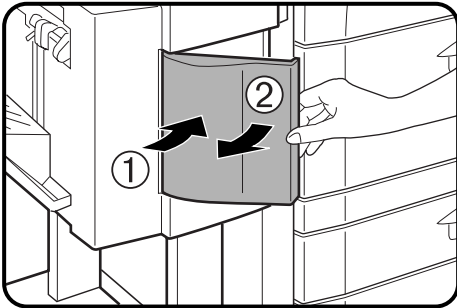

1 Close and open the stapler cover.

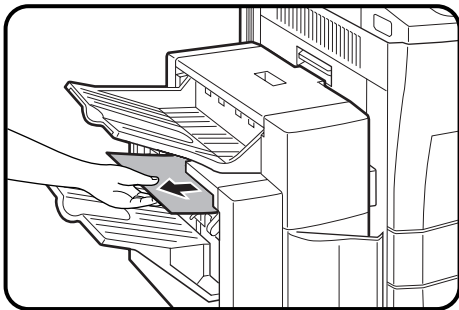

2 Remove all copies from the tray.

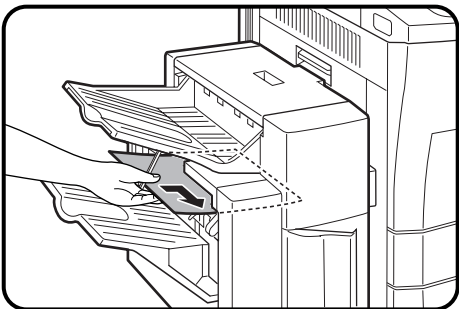

3 Insert a new sheet of paper (8-1/2" x 11" or A4 size) to the tray as shown in the picture to make the stapler work properly.

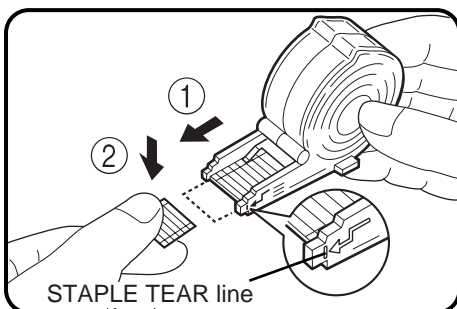

4 Check that the first staple of the cartridge is at the tip of the cartridge.

- If the first staple is not at the tip, pull it to the tip. If any staples are protruding past the cartridge tip, tear them off at the STAPLE TEAR line and align the first staple with the tip.

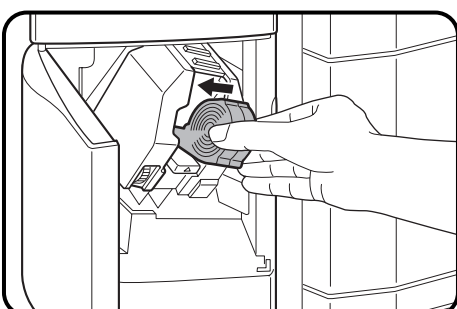

5 Push the staple cartridge in until it locks in place.

6 Close the stapler cover.

- The stapler will strike three times, whereupon the jammed staples will have been removed automatically.
- Remove the paper from the tray.
- To check that the stapler works properly, copy an original and staple it.

Misfeed removal

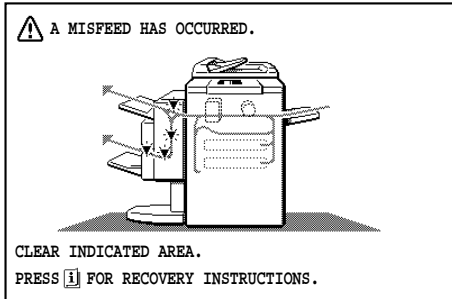

The copier will stop when a misfeed occurs. The message "A MISFEED HAS OCCURRED. CLEAR INDICATED AREA. PRESS [i] FOR RECOVERY INSTRUCTIONS." will appear along with a display of paper misfeed locations. Press the INFORMATION key for more detailed information.

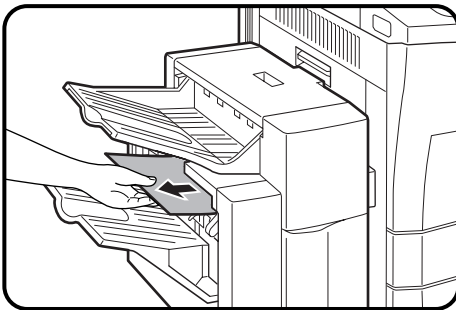

1 If the offset tray has been used, remove the misfed paper.

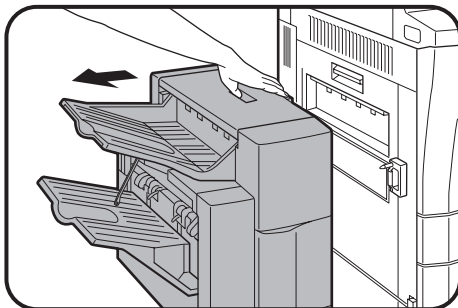

2 While holding the finisher release lever, slide the finisher away from the copier.

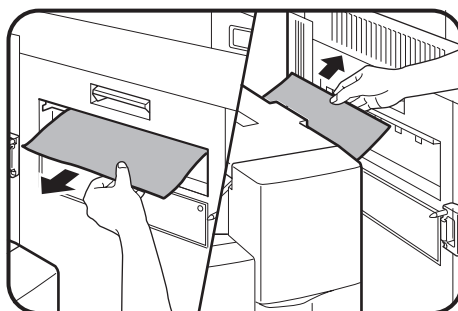

3 Remove the misfed paper.

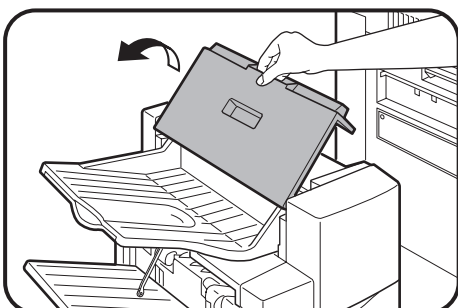

4 Open the top cover.

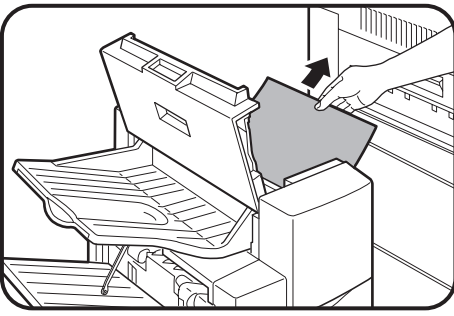

5 Remove the misfed paper.

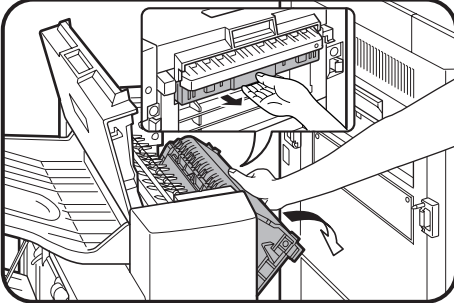

6 Rotate the paper feed area cover as shown to open it.

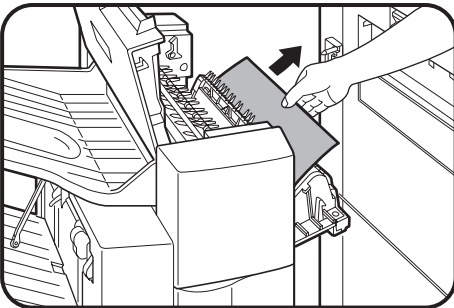

7 Remove the misfed paper.

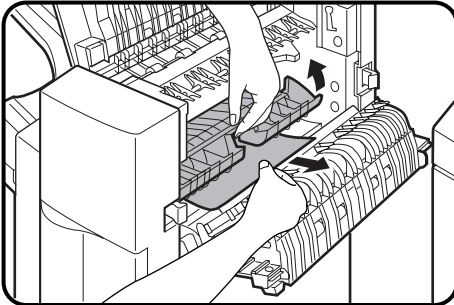

8 Open the paper guide and remove the misfed paper.

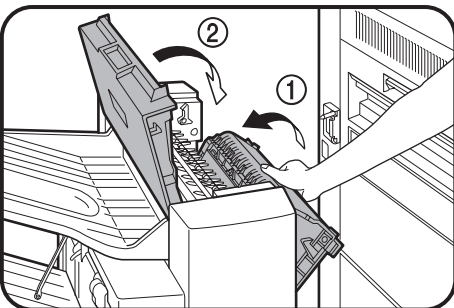

9 Close the paper feed area cover and then close the top cover.

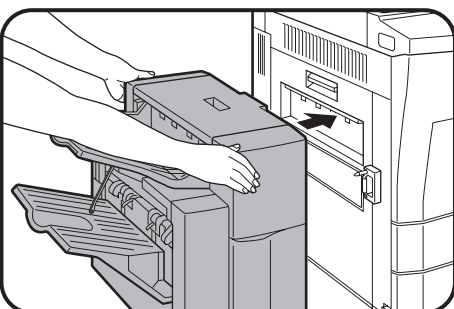

10 Push the finisher toward the copier and latch it in place.

- Confirm that the misfeed display has cleared.

LARGE CAPACITY TRAY (AR-LC1N)

The large capacity tray provides the added convenience of having 3,000 additional sheets of 8-1/2" x 11" paper available.

NOTE:

To install the large capacity tray, an optional stand/500-sheet paper drawer (AR-DE1N) or an equivalent stand must be installed.

PART NAMES

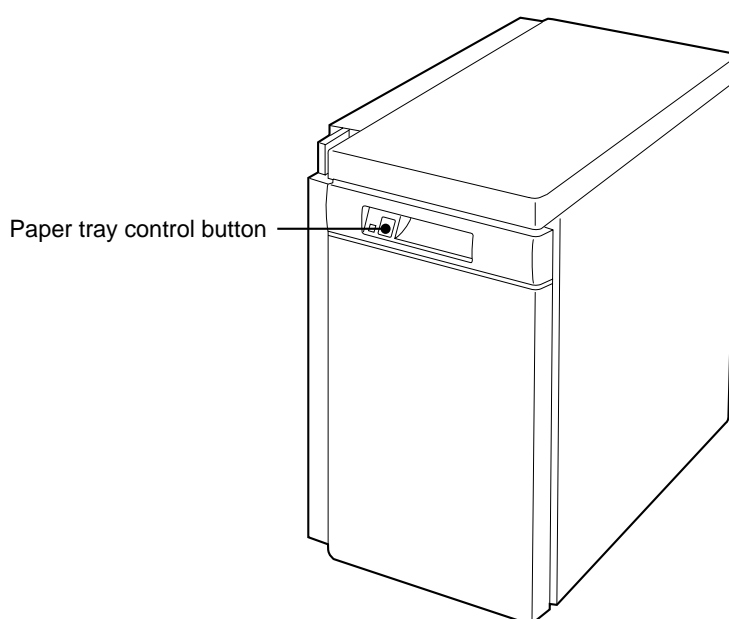

Specifications

Paper size	8-1/2" x 11"
Paper weight	15 lbs. to 28 lbs.
Paper capacity	3,000 sheets
Weight	Approx. 70.6 lbs. (32 kg)
Dimensions	13" (W) x 21-17/64" (D) x 22-61/64" (H) (330 mm (W) x 540 mm (D) x 583 mm (H))

Specifications are subject to change for improvement without notice.

Loading copy paper

The large capacity tray will automatically lower when the tray runs out of paper.



1 Press the paper tray control button on the large capacity tray.

- The button lamp will blink while the feed table is lowering and will go out when the tray is ready to be opened.

2 When the button lamp goes out, pull the paper tray out.

- Do not pull the paper tray out before the button lamp goes out.

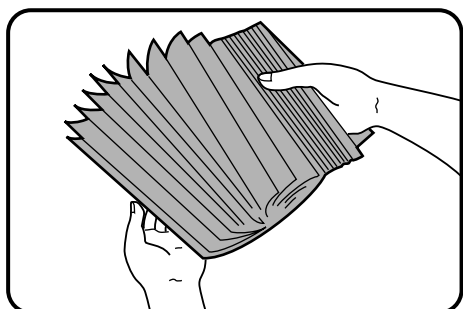

3 Fan the copy paper.

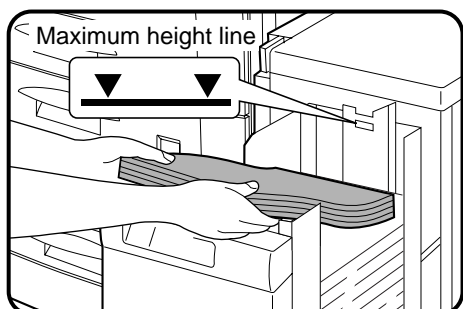

4 Load the paper onto the feed table.

- Be sure to load paper appropriate for the large capacity tray. See page 7-30.
- Do not exceed the maximum height line.

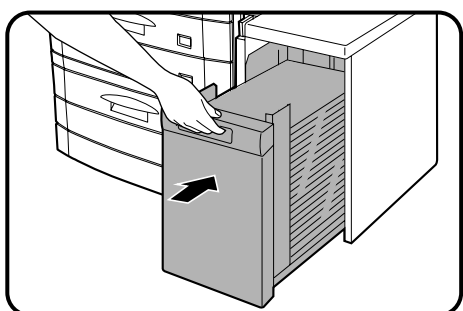

5 Gently push the large capacity tray back into place.

- The paper tray control button lamp will blink as the feed table returns to the feed position and will light up steadily when it is in position to feed.

Misfeed removal

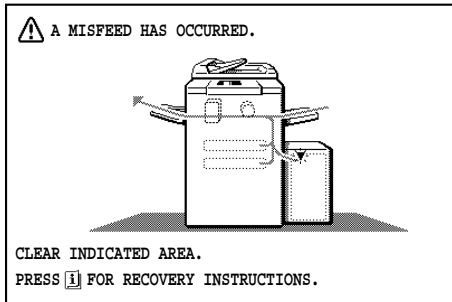

The copier will stop when a misfeed occurs.

The message "A MISFEED HAS OCCURRED. CLEAR INDICATED AREA. PRESS [i] FOR RECOVERY INSTRUCTIONS." will appear with a display of paper misfeed locations. Press the INFORMATION key for more detailed information as necessary.

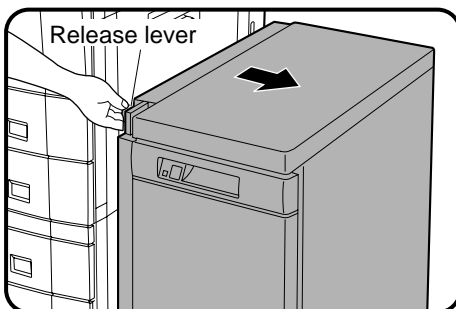

- 1 While holding the tray release lever, carefully slide the large capacity tray away from the copier until it stops.

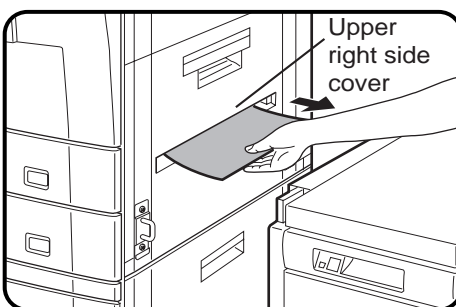

- 2 Remove any misfed paper from the copier and the large capacity tray.

- Be sure not to tear the misfed paper during removal.
- Open and close the upper right side cover of the copier after removing the misfed paper from the copier.

If the misfed paper cannot be removed easily, open the upper right side cover to remove the paper.

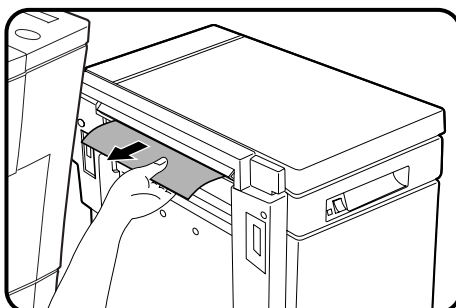



3 Push the large capacity tray toward the copier and latch it into place.

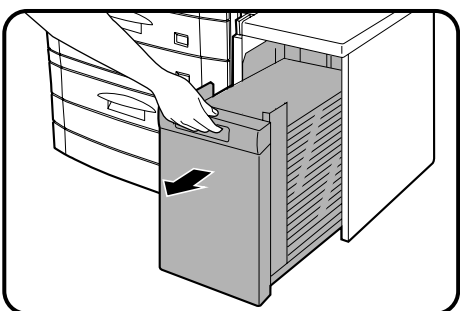

4 If misfed paper is not found in step 2, pull the tray out.

- When pulling the large capacity tray out, be sure to pull it out after the paper tray control button lamp goes out.

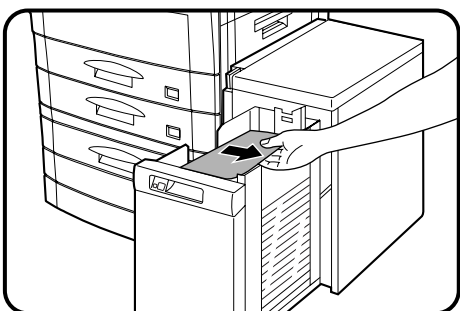

5 Remove the misfed paper.

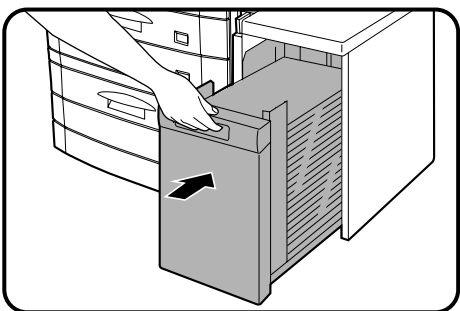

6 Gently push the tray back into place.

- Confirm that the misfeed display is cleared.

STAND/500-SHEET PAPER DRAWER (AR-DE1N)

This optional stand with a paper tray provides the convenience of increased paper capacity for the copier and a greater choice of paper sizes readily available for copying. Even greater paper capacity and size flexibility are available when the stand is equipped with an optional auxiliary 500-sheet paper drawer (AR-CS1).

The AR-DE1N is available with a 500-sheet paper drawer alone or with an optional auxiliary 500-sheet paper drawer for the additional flexibility of two feeds with a total capacity of 1,000 sheets.

PART NAMES

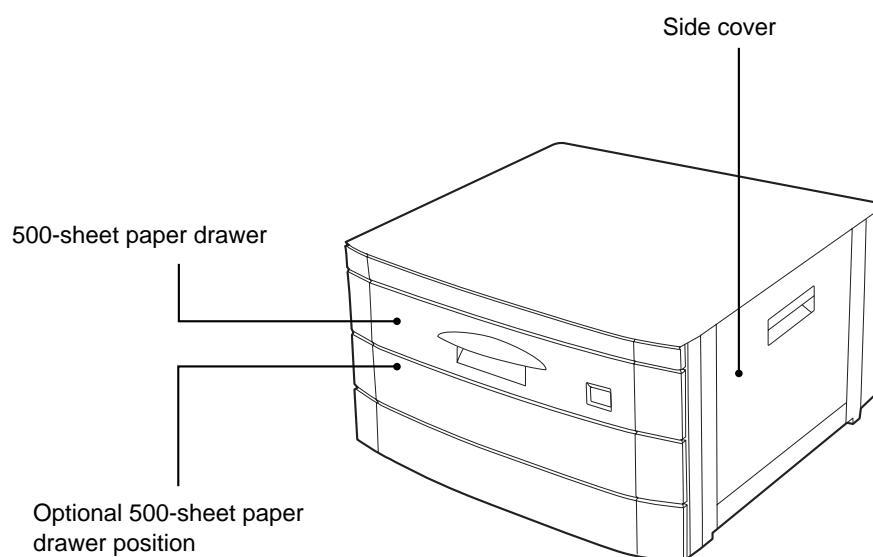

Specifications

Paper size	8-1/2" x 11" to 11" x 17"
Paper weight	15 lbs. to 28 lbs.
Paper capacity	500 sheets of 20 lb. bond paper Total of 1,000 sheets of 20 lb. bond paper with an optional 500-sheet paper drawer installed
Weight	Approx. 55.2 lbs. (25 kg)
Dimensions	23-5/8" (W) x 23-25/32" (D) x 15-7/8" (H) (600 mm (W) x 604 mm (D) x 403 mm (H))

Specifications are subject to change for improvement without notice.

Loading copy paper

The method of loading of copy paper for the paper tray of the 500-sheet paper drawer is the same as for the paper trays in the copier. See page 4-3.

The method of changing the copy paper size is also the same for the paper trays in the copier. See page 4-4.

Misfeed removal

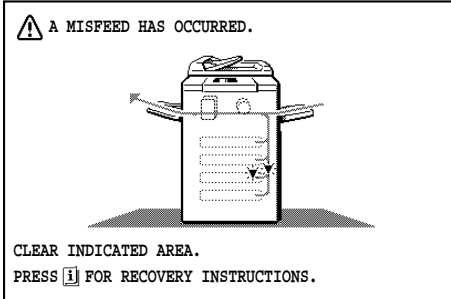

The copier will stop when a misfeed occurs.

The message "A MISFEED HAS OCCURRED. CLEAR INDICATED AREA. PRESS **i** FOR RECOVERY INSTRUCTIONS." will appear with a display of paper misfeed locations. Press the INFORMATION key for more detailed information as necessary.

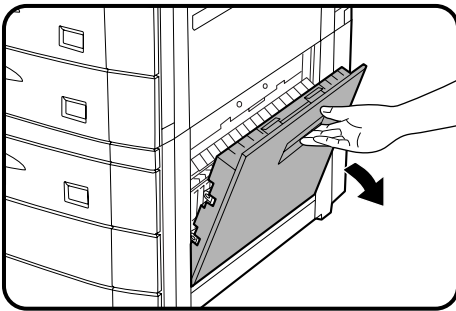

1 Open the lower right side cover and remove any misfed paper.

- Be sure to perform this step before pulling out the paper drawer. If not, the paper may be torn as the drawer is opened.
- Be sure not to tear the misfed paper during removal.

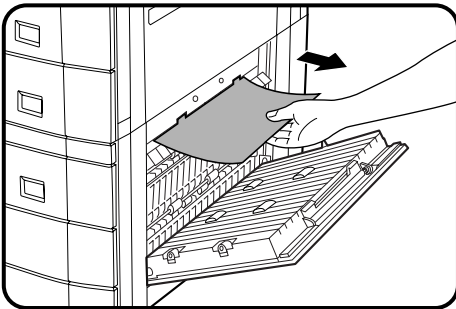

2 Gently lift and pull out the paper drawer. Remove any misfed paper.

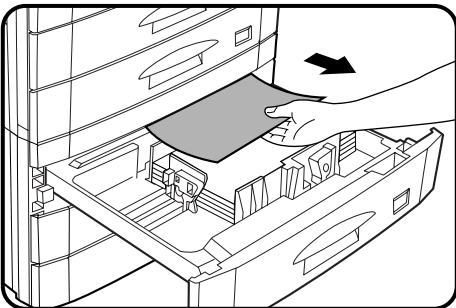

3 Close the paper drawer and the lower right side cover.

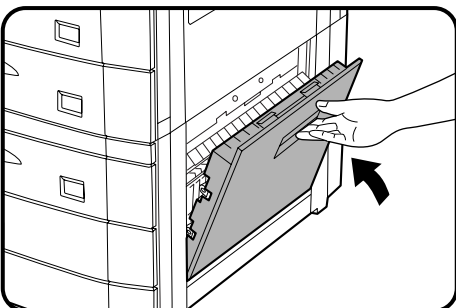

4 Open and close the front cover to cancel the misfeed display.

- Confirm that the misfeed display is cleared.

DUAL TRAY OUTPUT UNIT (AR-TR1)

This optional unit can deliver interrupt copies to the lower exit tray.

PART NAMES

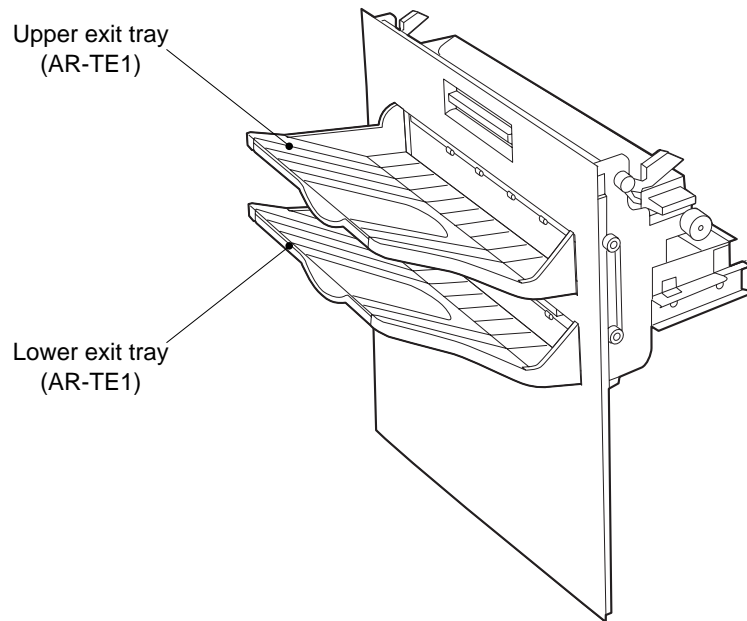

Upper exit tray (First tray)

- Ordinary (non-interrupt) copies are deposited in the upper exit tray.

Lower exit tray (Second tray)

- Interrupt copies are deposited in the lower exit tray.
A key operator program can disable output to the lower exit tray in interrupt copying.
See page 26 of the KEY OPERATOR'S GUIDE.

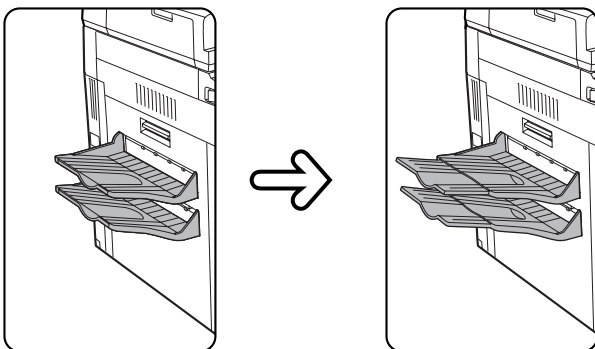

- Be sure to extend the tray when feeding 8-1/2" x 14" or 11" x 17" sized paper.

Specifications

Exit tray capacity	Upper tray : 250 sheets Lower tray : 100 sheets
Paper size	Upper tray : 5-1/2" x 8-1/2" to 11" x 17" Lower tray : 5-1/2" x 8-1/2" to 11" x 17"
Paper weight	Upper tray : 14 lbs. to 34 lbs. Lower tray : 15 lbs. to 28 lbs.
Power supply	Drawn from the copier
Weight	Approx. 7.3 lbs. (3.3 kg)

Specifications are subject to change for improvement without notice.

WARNING:

FCC Regulations state that any unauthorized changes or modifications to this equipment not expressly approved by the manufacturer could void the user's authority to operate this equipment.

Note:

This equipment has been tested and found to comply with the limits for a Class A digital device, pursuant to Part 15 of the FCC Rules. These limits are designed to provide reasonable protection against harmful interference when the equipment is operated in a commercial environment. This equipment generates, uses, and can radiate radio frequency energy and, if not installed and used in accordance with the operation manual, may cause harmful interference to radio communications. Operation of this equipment in a residential area is likely to cause harmful interference in which case the user will be required to correct the interference at his own expense.

NOTICE

BE SURE TO ASK YOUR AUTHORIZED SHARP DEALER ABOUT THE WARRANTY THAT YOUR SELLING DEALER EXTENDS TO YOU. In order to assure you, the end-user, of warranty protection, Sharp extends a limited warranty to each of its authorized dealers and, in turn, requires each of its authorized dealers to extend its own warranty to you on terms that are no less favorable than those given to the dealer by Sharp. You should be aware, however, that Sharp does not itself extend any warranties, either express or implied, directly to you, the end-user and no one is authorized to make any representations or warranties on behalf of Sharp. Specifically, SHARP DOES NOT EXTEND TO YOU, THE END-USER, ANY EXPRESS WARRANTY OR ANY IMPLIED WARRANTY OF MERCHANTABILITY, FITNESS FOR USE OR FITNESS FOR ANY PARTICULAR PURPOSE IN CONNECTION WITH THE HARDWARE, SOFTWARE OR FIRMWARE EMBODIED IN, OR USED IN CONJUNCTION WITH THIS PRODUCT. Sharp is not responsible for any damages or loss, either direct, incidental or consequential, which you, the end-user, may experience as a result of your purchase or use of the hardware, software or firmware embodied in or used in conjunction with this Product. Your sole remedy, in the event that you encounter any difficulties with this Product, is against the authorized dealer from which you purchased the Product.

In the event that this authorized dealer does not honor its warranty commitments, please contact the General Manager , Business Products Group, Sharp Electronics Corporation, Sharp Plaza, Mahwah, NJ 07430-2135, so that Sharp can try to help assure complete satisfaction of all the warranty rights to which you are entitled from the authorized dealer.

SHARP[®]

SHARP ELECTRONICS CORPORATION
Sharp Plaza, Mahwah, New Jersey 07430-2135.

SHARP CORPORATION